



# TABLES FOR STEEL CONSTRUCTIONS

BY

**Prof. Dr. MOUSTAFA KORASHY**

# **TABLES FOR STEEL CONSTRUCTIONS**

**BY**

**Prof. Dr. MOUSTAFA KORASHY**

**CHECKED BY**

**Dr. SHERIF IBRAHIM**

**Eng. MOHAMED KORASHY**

**2001**

# CONTENTS

<b>List of symbols</b>	<b>i</b>
<b>Introduction</b>	<b>ii</b>
<b>Hot Rolled Sections</b>	<b>1</b>
<b>Combined Hot Rolled Sections</b>	<b>26</b>
<b>Cold Formed Sections</b>	<b>46</b>
<b>Combined Cold Formed Sections</b>	<b>50</b>
<b>Bolts</b>	<b>55</b>
<b>Sample of Corrugated Sheets</b>	<b>66</b>
<b>Accessories</b>	<b>76</b>
<b>Cranes</b>	<b>79</b>
<b>Welding Symbols</b>	<b>86</b>
<b>Miscellaneous</b>	<b>90</b>

## LIST OF SYMBOLS

$a$  (mm): Length of long leg for unequal angle.

$b$  (mm): Length of short leg for unequal angle,  
or flange width.

$b_1$  (mm): Width of upper flange for unsymmetrical welded I-sections.

$b_2$  (mm): Width of Lower flange for symmetrical welded I-sections.

$c$  (mm): Height of curved part including flange thickness for channel and I-sections.

$D$  (mm): Outer diameter of pipe.

$d$  (mm): Height of web for built-up I-sections.

$d_{\max}$  (mm): Maximum diameter of bolt to be used.

$e$  (mm): Distance measured from outer surface to neutral axis of section.

$e_x$  (mm): Distance from bottom surface to X-X axis.

$e_y$  (mm): Distance from outer surface to Y-Y Axis.

$h$  (mm): Height of section.

$I$  (cm<sup>4</sup>): Moment of inertia for symmetrical section.

$I_u$  (cm<sup>4</sup>): Moment of inertia about U-U axis.

$I_v$  (cm<sup>4</sup>): Moment of inertia about V-V axis.

$I_x$  (cm<sup>4</sup>): Moment of inertia about X-X axis.

$I_y$  (cm<sup>4</sup>): Moment of inertia about Y-Y axis.

$I_{y \text{ upper flange}}$  (cm<sup>4</sup>): Moment of inertia for upper flange about Y-Y axis.

$J$  (cm<sup>4</sup>): Torsion constant.

$r$  (mm, cm): Radius of inner fillet for cold formed section,  
or Radius of gyration for symmetrical section.

$r_1$  (mm): Radius of fillet between web and flange.

$r_u$  (cm): Radius of gyration about U-U axis.

$r_v$  (cm): Radius of gyration about V-V axis.

$r_x$  (cm): Radius of gyration about X-X axis.

$r_y$  (cm): Radius of gyration about Y-Y axis.

$s$  (mm): Thickness of web,  
or Thickness of angle leg

$S$  (cm<sup>3</sup>): Elastic modulus of section.

$S_v$  (cm<sup>3</sup>): Elastic modulus of section about V-V axis.

$S_x$  (cm<sup>3</sup>): Elastic modulus of section about X-X axis.

$S_{xb}$  (cm<sup>3</sup>): Elastic modulus of bottom extreme fibers about X-X axis.

$S_{xt}$  (cm<sup>3</sup>): Elastic modulus of top extreme fibers about X-X axis.

$S_y$  (cm<sup>3</sup>): Elastic modulus of section about Y-Y axis.

$S_{y \text{ upper flange}}$  (cm<sup>3</sup>): Elastic modulus of upper flange about Y-Y axis.

$t$  (mm): Thickness of flange,  
or Wall thickness.

$t_G$  (mm): Thickness of gusset plate.

$u_1, u_2$  (cm): Distance between outer fibers of an angle to V-V axis.

$U_m$  (m<sup>2</sup>/m): Surface area per unit length.

$U_t$  (m<sup>2</sup>/t): Surface area per unit weight.

$v, v_1, v_2$  (cm): Distance between outer fibers of an angle to U-U axis.

$w, w_1$  (mm): Distance determining bolt hole location relative to the section.

$X_m$  (cm): Distance between centroid of a channel and its shear center.

# Introduction

The aim of presenting these tables is to provide the structural engineers with wide range of information required in designing steel structures. Previously, a steel designer had to search in many tables, handbooks, manuals, ...etc. to collect the necessary information needed to complete his/her design.

These tables are divided into nine chapters. Chapter one provides the geometrical properties of common hot rolled sections which includes the following:

- Equal and unequal angles: primarily used in trusses for resisting axial forces.

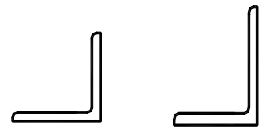

- Channels (UPN): used as truss members and purlins or side girts.



- I-sections (IPN, IPE, HEA, HEB, HEM):

IPN section is suitable for beam subjected to bending moment about its major axis.

IPE section used mainly for beams or beam column.

HEA, HEB, and HEM sections are primarily used for members subjected to bi-moments or for heavy beam-columns.

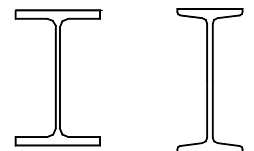

- T-sections are produced by cutting I-sections into two halves. They are used as brackets, truss members or light beams.

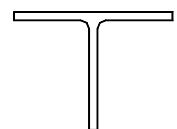

- Pipes and hollow sections: primarily used as truss members in welded trusses.

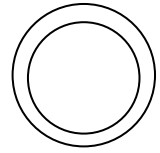

Hollow square and rectangular sections, sometimes used as roof purlins or light beam-columns.

- Flat plates used in connections as head plates, gusset plates or it can be utilized in composing built-up section.

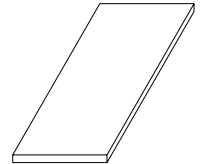

- Rails: used mainly in tracks of moving structures such as crane bridge.

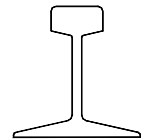

In unprecedented presentation of section properties in the Egyptian practice, Chapter two introduces the geometric properties for combined hot rolled sections and built-up welded sections.

This chapter provides the properties for the following combined sections:

- Two equal or unequal angles back to back:  
Used mainly as lower or upper chord of trusses, or bracing members.



- Two channels back to back:  
Used mainly as lower or upper chord in heavy trusses.

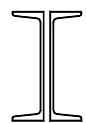

- Two channels toe to toe:  
Used as beam-column especially when the buckling lengths in-plane and out of plane are nearly equal.



- IPE and UPN:

This section is used primarily as section for crane girders. The “UPN” section is provided at the top flange where the lateral shock of the crane bridge is applied.

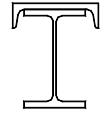

- Symmetrical welded I-Section:

This section consists of three parts welded to form symmetrical I-sections. It is used mainly for beams or beam-columns.

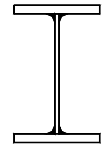

- Unsymmetrical welded I-sections:

This section is formed in away to make the upper flange approximately twice the lower flange. Thus it is suitable for crane girders where the lateral shock is applied at the upper flange. The section might also be used for composite construction when the upper and lower flanges are switched.

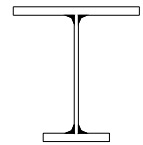

Chapter three introduces the geometrical properties of cold-formed steel sections, these sections includes:

- Channels (stiffened and unstiffened) and Z sections (with straight lips and with inclined lips): These sections are used mainly for roof purlins and side girts. Sometimes, they can be used in light trusses as web members.

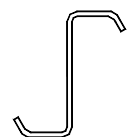
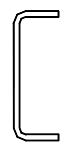



Chapter four provides the geometrical properties for combined cold-formed sections. These sections includes:

- Two channels back to back:

Used as lower or upper chord in light trusses or in bracing members.

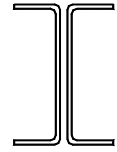

- Two channels toe to toe:

Used in light beam columns or as eave struts I bracing system.

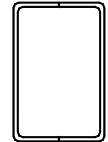

Chapter five provides complete information about the size, weight, and grip length of ordinary and high strength bolts. It also provides the dimension and weight of washers and nuts used for each type of bolts.

This chapter also includes the dimension and the weight of anchor bolts with various configurations.

Chapter six provides the geometrical properties of sample of corrugated sheets whether they are single layer, sandwich panels, or metal decking steel sheets. In this chapter the allowable spacing between purlins is also provided based on the strength and serviceability criteria.

Chapter seven includes samples of the wheel loads of crane bridges covering the following ranges of crane capacities:

- Light cranes with capacity range from 0.5 to 6.3 ton.
- Normal cranes with capacity range from 2.0 to 25 ton.
- Heavy cranes with capacity range from 25 to 63 ton.

Chapter eight provides the common symbols used in welding constructions.

Chapter nine includes various data covering the following areas:

- Conversion tables used to convert engineering units from imperial to SI or metric systems and vice versa.
- Dimensions of aircraft with various types to assist in choosing the configuration of aircraft hangar.
- Geometrical properties of common shapes in engineering practice.

# HOT ROLLED SECTIONS

EQUAL ANGLES

HALF I.P.E.

UNEQUAL ANGLE

HALF H.E.A.

CHANNELS (U.P.N)

HALF H.E.B.

I.P.N.

PIPES

I.P.E.

HOLLOW SQUARE SECTIONS

H.E.A.

HOLLOW RECTANGULAR SECTIONS

H.E.B.

PLATES

H.E.M.

RAILS

# EQUAL ANGLES

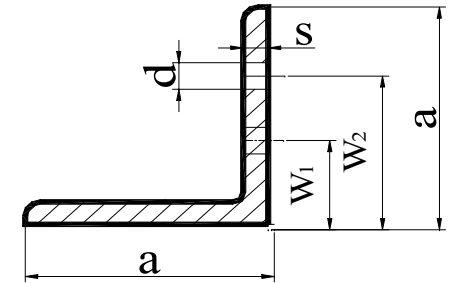
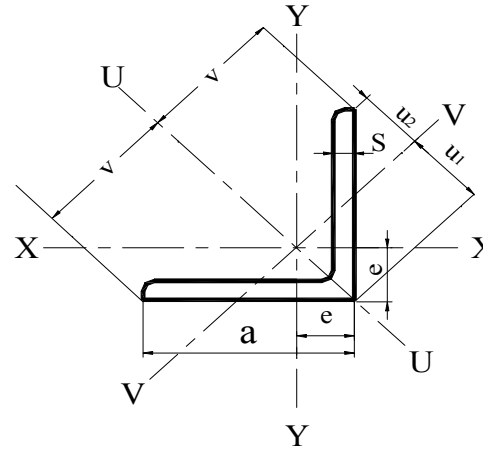

Size		Weight	Area	Dimensions				Axis X-X and Y-Y			Axis u-u		Axis v-v			Details			Surface Area	
a	s			e	v	u <sub>1</sub>	u <sub>2</sub>	l	S	r	l <sub>u</sub>	r <sub>u</sub>	l <sub>v</sub>	S <sub>v</sub>	r <sub>v</sub>	w <sub>1</sub>	w <sub>2</sub>	d <sub>max</sub>	U <sub>m</sub>	U <sub>t</sub>
mm	mm	kg/m	cm <sup>2</sup>	cm	cm	cm	cm	cm <sup>4</sup>	cm <sup>3</sup>	cm	cm <sup>4</sup>	cm	cm <sup>4</sup>	cm <sup>3</sup>	cm	mm	mm	mm	x10 <sup>-2</sup> m <sup>2</sup> /m	m <sup>2</sup> /t
30	3	1.36	1.74	0.84	2.12	1.18	1.04	1.41	0.65	0.90	2.24	1.14	0.57	0.48	0.57	N.A.			11.60	85.30
	4	1.78	2.27	0.89		1.24	1.05	1.81	0.86	0.89	2.85	1.12	0.76	0.61	0.58				11.60	65.17
	5	2.18	2.78	0.92		1.30	1.07	2.16	1.04	0.88	3.41	1.11	0.91	0.70	0.57				11.60	53.21
35	3	1.60	2.04	0.96	2.47	1.36	1.23	2.29	0.90	1.06	3.63	1.34	0.95	0.70	0.68	20	N.A.	M10	13.60	85.00
	4	2.10	2.67	1.00		1.41	1.24	2.96	1.18	1.05	4.68	1.33	1.24	0.88	0.68	20		M10	13.60	64.76
	5	2.57	3.28	1.04		1.47	1.25	3.56	1.45	1.04	5.63	1.31	1.49	1.10	0.67	20		M10	13.60	52.91
40	4	2.42	3.08	1.12	2.83	1.58	1.40	4.48	1.56	1.21	7.09	1.52	1.86	1.18	0.78	22	N.A.	M10	15.50	64.00
	5	2.97	3.79	1.16		1.64	1.42	5.43	1.91	1.20	8.64	1.51	2.22	1.35	0.77	22		M10	15.50	52.20
	6	3.52	4.48	1.20		1.70	1.43	6.33	2.26	1.19	9.98	1.49	2.67	1.57	0.77	22		M10	15.50	44.03
45	5	3.38	4.30	1.28	3.18	1.81	1.58	7.83	2.43	1.35	12.40	1.70	3.25	1.80	0.87	25	N.A.	M12	17.40	51.50
	6	4.00	5.09	1.32		1.87	1.59	9.16	2.88	1.34	14.50	1.69	3.85	2.05	0.87	25		M12	17.40	43.50
	7	4.60	5.86	1.36		1.92	1.61	10.40	3.31	1.33	16.40	1.67	4.39	2.29	0.87	25		M12	17.40	37.82
50	5	3.77	4.80	1.40	3.54	1.98	1.76	11.00	3.05	1.51	17.40	1.90	4.59	2.32	0.98	30	N.A.	M12	19.40	51.50
	6	4.47	5.69	1.45		2.04	1.77	12.80	3.51	1.50	20.40	1.89	5.24	2.57	0.96	30		M12	19.40	43.40
	7	5.15	6.56	1.49		2.11	1.78	14.60	4.15	1.49	23.10	1.88	6.02	2.85	0.96	30		M12	19.40	37.67
55	5	4.18	5.32	1.52	3.89	2.15	1.93	14.70	3.70	1.66	23.30	2.09	6.11	2.84	1.07	30	N.A.	M16	21.30	50.96
	6	4.95	6.31	1.56		2.21	1.94	17.80	4.40	1.66	27.40	2.08	7.24	3.26	1.07	30		M16	21.30	33.30
	8	6.46	8.23	1.64		2.32	1.97	22.10	5.72	1.64	34.80	2.06	9.35	4.03	1.07	30		M16	21.30	32.97
60	6	5.42	6.91	1.69	4.24	2.39	2.11	22.80	5.29	1.82	36.10	2.29	9.43	3.85	1.17	35	N.A.	M16	23.30	43.00
	8	7.09	9.03	1.77		2.50	2.14	29.10	6.88	1.80	46.10	2.26	12.10	4.84	1.16	35		M16	23.30	32.90
	10	8.69	11.10	1.85		2.62	2.17	34.90	8.41	1.78	55.10	2.23	14.60	5.57	1.15	35		M16	23.30	26.80
65	7	6.83	8.70	1.85	4.60	2.62	2.29	33.40	7.13	1.96	53.00	2.47	13.80	5.27	1.26	35	N.A.	M16	25.20	36.90
	8	7.73	9.85	1.89		2.67	2.31	37.50	8.13	1.95	59.40	2.46	15.60	5.84	1.26	35		M16	25.20	32.60
	9	8.62	11.00	1.93		2.73	2.32	41.30	9.04	1.94	65.40	2.44	17.20	6.30	1.25	35		M16	25.20	29.23

N.A.=not available for this angle size

# EQUAL ANGLES

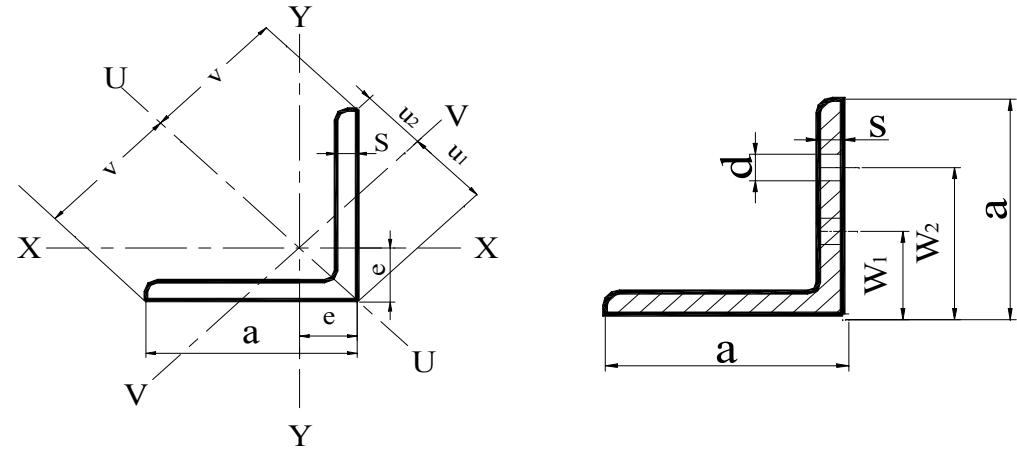

Size		Weight	Area	Dimensions				Axis X-X and Y-Y			Axis u-u		Axis v-v			Details			Surface Area	
a	s			e	v	u <sub>1</sub>	u <sub>2</sub>	l	S	r	l <sub>u</sub>	r <sub>u</sub>	l <sub>v</sub>	S <sub>v</sub>	r <sub>v</sub>	w <sub>1</sub>	w <sub>2</sub>	d <sub>max</sub>	U <sub>m</sub>	U <sub>t</sub>
mm	mm	kg/m	cm <sup>2</sup>	cm	cm	cm	cm	cm <sup>4</sup>	cm <sup>3</sup>	cm	cm <sup>4</sup>	cm	cm <sup>4</sup>	cm <sup>3</sup>	cm	mm	mm	mm	x10 <sup>-2</sup> m <sup>2</sup> /m	m <sup>2</sup> /t
70	7	7.38	9.40	1.97	4.95	2.79	2.47	42.4	8.43	2.12	67.1	2.67	17.6	6.37	1.37	40	N.A.	M20	27.20	36.90
	9	9.34	11.90	2.05		2.90	2.50	52.6	10.6	2.10	83.1	2.64	22.0	7.59	1.36	40		M20	27.20	29.10
	11	11.20	14.30	2.13		3.01	2.53	61.8	12.7	2.09	97.6	2.61	26.0	8.61	1.35	40		M20	27.20	24.28
75	7	7.94	10.10	2.03	5.30	2.95	2.63	52.4	8.67	2.28	83.6	2.88	21.1	7.15	1.45	40	N.A.	M20	29.10	36.65
	8	9.03	11.50	2.13		3.01	2.65	58.9	11.0	2.26	93.3	2.85	24.4	8.11	1.46	40		M20	29.10	32.20
	10	11.10	14.10	2.21		3.18	2.68	71.4	13.5	2.25	113	2.83	28.8	9.55	1.45	40		M20	29.10	26.21
80	8	9.66	12.30	2.26	5.66	3.20	2.82	72.3	12.6	2.42	115	3.06	29.6	9.25	1.55	45	N.A.	M20	31.10	32.20
	10	11.90	15.10	2.34		3.31	2.85	87.5	15.5	2.41	139	3.03	35.9	10.9	1.54	45		M20	31.10	26.10
	12	14.10	17.90	2.41		3.41	2.89	102	18.2	2.39	161	3.00	43.0	12.6	1.53	45		M20	31.10	22.10
90	9	12.20	15.50	2.54	6.36	3.59	3.18	116	18.0	2.74	184	3.45	47.8	13.3	1.76	50	N.A.	M20	35.10	28.80
	11	14.70	18.70	2.62		3.70	3.21	138	21.6	2.72	218	3.41	57.1	15.4	1.75	50		M20	35.10	23.88
	13	17.10	21.80	2.70		3.81	3.24	158	25.1	2.69	250	3.39	65.9	17.3	1.74	50		M20	35.10	20.53
100	10	15.10	19.20	2.82	7.07	3.99	3.54	177	24.7	3.04	280	3.82	73.3	18.4	1.95	55	N.A.	M24	39.00	25.80
	12	17.80	22.70	2.90		4.10	3.57	207	29.2	3.02	328	3.80	86.2	21.0	1.95	55		M24	39.00	21.90
	14	20.60	26.20	2.98		4.21	3.60	235	33.5	3.00	372	3.77	98.3	23.4	1.94	55		M24	39.00	18.90
110	10	16.60	21.20	3.07	7.78	4.34	3.89	239	30.1	3.36	379	4.23	98.6	22.7	2.16	40	80	M20	43.00	25.90
	12	19.70	25.10	3.15		4.45	3.93	280	35.7	3.34	444	4.21	116	25.1	2.15	40	80	M20	43.00	21.83
	14	22.80	29.00	3.21		4.54	3.98	319	41.0	3.32	505	4.18	133	29.3	2.14	40	80	M20	43.00	18.86
120	12	21.60	27.50	3.40	8.49	4.80	4.26	368	42.7	3.65	584	4.60	152	31.6	2.35	45	85	M20	46.90	21.70
	13	23.30	29.90	3.44		4.86	4.27	394	46.0	3.64	625	4.59	162	33.3	2.34	45	85	M20	46.90	20.13
	15	26.60	33.90	3.51		4.96	4.31	446	52.5	3.63	705	4.56	186	37.5	2.34	45	85	M20	46.90	17.60

N.A.=not available for this angle size

# EQUAL ANGLES

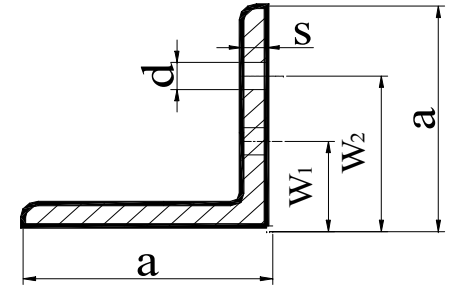
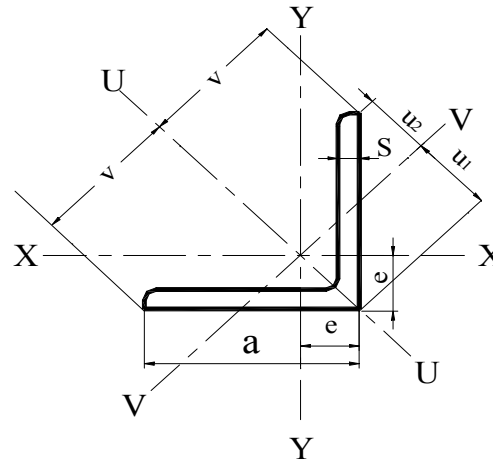

Size		Weight	Area	Dimensions				Axis X-X and Y-Y			Axis u-u		Axis v-v			Details			Surface Area	
a	s			e	v	u <sub>1</sub>	u <sub>2</sub>	I	S	r	I <sub>u</sub>	r <sub>u</sub>	I <sub>v</sub>	S <sub>v</sub>	r <sub>v</sub>	w <sub>1</sub>	w <sub>2</sub>	d <sub>max</sub>	U <sub>m</sub>	U <sub>t</sub>
mm	mm	kg/m	cm <sup>2</sup>	cm	cm	cm	cm	cm <sup>4</sup>	cm <sup>3</sup>	cm	cm <sup>4</sup>	cm	cm <sup>4</sup>	cm <sup>3</sup>	cm	mm	mm	mm	x10 <sup>-2</sup> m <sup>2</sup> /m	m <sup>2</sup> /t
130	12	23.60	30.00	3.64	9.19	5.15	4.60	472	50.4	3.97	750	5.00	194	37.7	2.54	50	90	M20	50.80	21.50
	14	27.20	34.70	3.72		5.26	4.63	540	55.2	3.94	857	4.97	223	42.4	2.53	50	90	M20	50.80	18.68
	16	30.90	39.30	3.80		5.37	4.66	605	65.8	3.92	959	4.94	251	46.7	2.52	50	90	M20	50.80	16.44
140	13	27.50	35.00	3.92	9.90	5.54	4.96	638	63.3	4.27	1010	5.38	262	47.3	2.74	55	105	M24	54.70	19.90
	15	31.40	40.00	4.00		5.66	4.99	723	72.3	4.25	1150	5.36	298	52.7	2.73	55	105	M24	54.70	17.40
150	14	31.60	40.30	4.21	10.60	5.95	5.31	845	78.2	4.58	1340	5.77	347	58.3	2.94	60	110	M24	58.60	18.50
	15	33.80	43.00	4.25		6.01	5.33	898	82.5	4.57	1430	5.76	370	61.6	2.93	60	110	M24	58.60	17.33
	16	35.90	45.70	4.29		6.07	5.34	949	88.7	4.56	1510	5.74	391	64.4	2.93	60	110	M24	58.60	16.30
	18	40.10	51.00	4.36		6.17	5.38	1050	99.3	4.54	1670	5.70	438	71.0	2.93	60	110	M24	58.60	14.61
160	20	44.20	56.30	4.44	11.30	6.28	5.41	1150	109	4.51	1820	5.68	477	76.0	2.91	60	110	M24	58.60	13.25
	15	36.20	46.10	4.49		6.35	5.67	1100	95.6	4.88	1750	6.15	453	71.3	3.14	60	120	M27	62.50	17.30
	17	40.70	51.80	4.57		6.46	5.70	1230	108	4.86	1950	6.13	506	78.3	3.13	60	120	M27	62.50	15.40
180	19	45.10	57.50	4.65	12.70	6.58	5.73	1350	118	4.84	2140	6.10	558	84.8	3.12	60	120	M27	62.50	13.85
	16	43.50	55.40	5.02		7.11	6.39	1680	130	5.51	2690	6.96	679	95.5	3.50	65	135	M27	70.50	16.20
	18	48.60	61.90	5.10		7.22	6.41	1870	145	5.49	2970	6.93	757	105	3.49	65	135	M27	70.50	14.50
	20	53.70	68.40	5.18		7.33	6.44	2040	160	5.47	3260	6.90	830	113	3.49	65	135	M27	70.50	13.12
200	22	58.60	74.70	5.26	14.10	7.44	6.47	2210	174	5.44	3510	6.86	918	123	3.50	65	135	M27	70.50	12.03
	16	48.50	61.80	5.52		7.80	7.09	2340	162	6.15	3740	7.78	943	121	3.91	65	150	M27	78.50	16.20
	18	54.30	69.10	5.60		7.92	7.12	2600	181	6.13	4150	7.75	1050	133	3.90	65	150	M27	78.50	14.50
	20	59.90	76.40	5.68		8.04	7.15	2850	199	6.11	4540	7.72	1160	144	3.89	65	150	M27	78.50	13.10
	24	71.10	90.60	5.84		8.26	7.21	3330	235	6.06	5280	7.64	1380	167	3.90	65	150	M27	78.50	11.04
	28	82.00	105.00	5.99		8.47	7.28	3780	270	6.02	5990	7.57	1580	186	3.89	65	150	M27	78.50	9.57

# UNEQUAL ANGLES

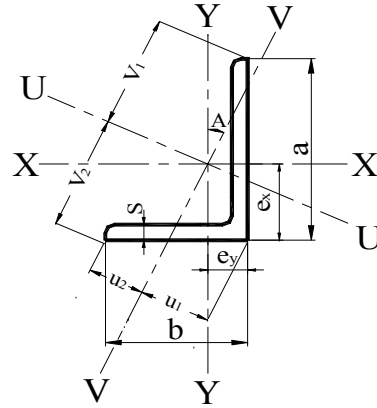

Size			Weight	Area	Dimensions						tan A	Axis X-X			Axis Y-Y			Axis u-u		Axis v-v		Details			Surface Area	
a	b	s			e <sub>x</sub>	e <sub>y</sub>	v <sub>1</sub>	v <sub>2</sub>	u <sub>1</sub>	u <sub>2</sub>		I <sub>x</sub>	S <sub>x</sub>	r <sub>x</sub>	I <sub>y</sub>	S <sub>y</sub>	r <sub>y</sub>	I <sub>u</sub>	r <sub>u</sub>	I <sub>v</sub>	r <sub>v</sub>	w <sub>1</sub>	w <sub>2</sub>	d <sub>max</sub>	U <sub>m</sub>	U <sub>t</sub>
mm	mm	mm	kg/m	cm <sup>2</sup>	cm	cm	cm	cm	cm	cm <sup>4</sup>	cm <sup>3</sup>	cm	cm <sup>4</sup>	cm <sup>3</sup>	cm	cm <sup>4</sup>	cm	cm <sup>4</sup>	cm	mm	mm	mm	x10 <sup>-2</sup> m <sup>2</sup> /m	m <sup>2</sup> /t		
30	20	3	1.11	1.42	0.99	0.50	2.04	1.51	0.86	1.04	0.431	1.25	0.62	0.94	0.44	0.29	0.56	1.43	1.00	0.25	0.42	N.A.			9.68	87.20
		4	1.45	1.85	1.03	0.54	2.02	1.52	0.91	1.03	0.423	1.59	0.81	0.93	0.55	0.38	0.55	1.81	0.99	0.33	0.42	N.A.			9.68	66.70
40	20	3	1.35	1.72	1.43	0.44	2.61	1.77	0.79	1.19	0.259	2.79	1.08	1.27	0.47	0.30	0.52	2.96	1.31	0.30	0.42	22	N.A.	M10	11.68	86.50
		4	1.77	2.25	1.47	0.48	2.57	1.80	0.83	1.18	0.252	3.59	1.42	1.26	0.60	0.39	0.52	3.79	1.30	0.39	0.42	22		M10	11.68	66.00
45	30	3	1.72	2.19	1.43	0.70	3.09	2.23	1.21	1.59	0.436	4.47	1.46	1.43	1.60	0.70	0.86	5.15	1.53	0.93	0.65	25	N.A.	M12	14.64	85.00
		4	2.25	2.87	1.48	0.74	3.07	2.26	1.27	1.58	0.433	5.78	1.91	1.42	2.05	0.91	0.85	6.65	1.52	1.18	0.64	25		M12	14.64	65.06
		5	2.77	3.53	1.52	0.78	3.05	2.27	1.32	1.58	0.430	6.99	2.95	1.41	2.47	1.11	0.84	8.02	1.51	1.44	0.64	25		M12	14.64	52.80
60	30	5	3.37	4.29	2.15	0.68	3.90	2.67	1.20	1.77	0.256	15.6	4.04	1.90	2.60	1.12	0.78	16.5	1.96	1.69	0.63	35	N.A.	M16	17.50	51.90
		7	4.59	5.85	2.24	0.76	3.83	2.72	1.28	1.73	0.248	20.7	5.50	1.88	3.41	1.52	0.76	21.8	1.93	2.28	0.62	35		M16	17.50	38.10
60	40	5	3.76	4.79	1.96	0.97	4.08	3.01	1.68	2.09	0.437	17.2	4.25	1.89	6.11	2.02	1.13	19.8	2.03	3.50	0.86	35	N.A.	M16	19.50	51.80
		6	4.46	5.68	2.00	1.01	4.06	3.02	1.72	2.08	0.437	20.1	5.03	1.88	7.12	2.38	1.12	23.1	2.02	4.12	0.85	35		M16	19.50	37.90
		7	5.14	6.55	2.04	1.05	4.04	3.03	1.77	2.07	0.422	23.0	5.79	1.87	8.07	2.74	1.11	26.3	2.00	4.73	0.85	35		M16	19.50	37.93
75	50	5	4.74	6.04	2.40	1.17	5.14	3.73	2.03	2.64	0.437	34.4	6.74	2.39	12.3	3.21	1.43	39.6	2.56	7.10	1.08	40	N.A.	M20	24.44	51.50
		7	6.51	8.30	2.48	1.25	5.10	3.77	2.13	2.63	0.433	46.4	9.24	2.36	16.5	4.39	1.41	53.3	2.53	9.56	1.07	40		M20	24.44	37.54
		9	8.23	10.50	2.56	1.32	5.06	3.80	2.22	2.62	0.427	57.4	11.6	2.34	20.2	5.49	1.39	65.7	2.50	11.9	1.07	40		M20	24.44	29.70
80	40	6	5.41	6.89	2.85	0.88	5.21	3.53	1.55	2.42	0.259	44.9	8.7	2.55	7.6	2.44	1.05	47.6	2.63	4.90	0.84	45	N.A.	M22	23.40	43.20
		8	7.07	9.01	2.94	0.95	5.15	3.57	1.65	2.38	0.253	57.6	11.4	2.53	9.7	3.18	1.04	60.9	2.60	6.41	0.84	45		M22	23.40	33.10
90	60	6	6.82	8.69	2.89	1.41	6.14	4.50	2.46	3.16	0.442	71.7	11.7	2.87	25.8	5.61	1.72	82.8	3.09	14.6	1.30	50	N.A.	M24	29.40	43.10
		8	8.96	11.40	2.97	1.49	6.11	4.54	2.56	3.15	0.497	92.5	15.4	2.85	33.0	7.31	1.70	107	3.06	19.0	1.29	50		M24	29.40	32.80
100	50	6	6.85	8.73	3.49	1.04	6.50	4.39	1.91	2.98	0.263	89.7	13.8	3.20	15.3	3.86	1.32	95.2	3.30	9.78	1.06	55	N.A.	M24	29.20	42.60
		8	8.99	11.50	3.59	1.13	6.48	4.44	2.00	2.95	0.258	116	18.0	3.18	19.5	5.04	1.31	123	3.28	12.6	1.05	55		M24	29.20	32.80
		10	11.10	14.10	3.67	1.20	6.43	4.49	2.08	2.91	0.252	141	22.2	3.16	23.4	6.17	1.29	149	3.25	15.5	1.04	55		M24	29.20	26.30
100	65	7	8.77	11.20	3.23	1.51	6.83	4.91	2.66	3.48	0.419	113	16.6	3.17	37.6	7.54	1.84	128	3.39	21.6	1.39	55	N.A.	M24	32.10	36.60
		9	11.10	14.20	3.32	1.59	6.78	4.94	2.76	3.46	0.415	141	21.0	3.15	46.7	9.52	1.82	160	3.36	27.2	1.39	55		M24	32.10	28.90
		11	13.40	17.10	3.40	1.67	6.74	4.97	2.85	3.45	0.410	167	25.3	3.13	55.1	11.4	1.80	190	3.34	32.6	1.38	55		M24	32.10	24.00

N.A.=not available for this angle size

# UNEQUAL ANGLES

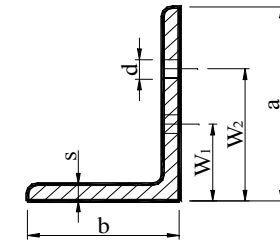
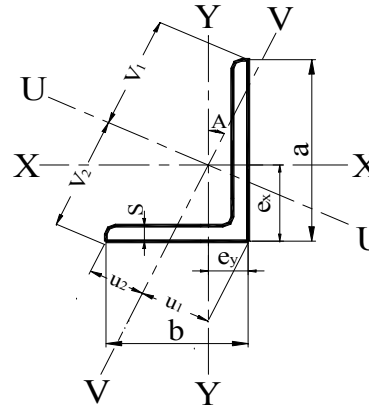

Size			Weight	Area	Dimensions						tan A	Axis X-X			Axis Y-Y			Axis u-u		Axis v-v		Details			Surface Area	
a	b	s			e <sub>x</sub>	e <sub>y</sub>	v <sub>1</sub>	v <sub>2</sub>	u <sub>1</sub>	u <sub>2</sub>		I <sub>x</sub>	S <sub>x</sub>	r <sub>x</sub>	I <sub>y</sub>	S <sub>y</sub>	r <sub>y</sub>	I <sub>u</sub>	r <sub>u</sub>	I <sub>v</sub>	r <sub>v</sub>	w <sub>1</sub>	w <sub>2</sub>	d <sub>max</sub>	U <sub>m</sub>	U <sub>t</sub>
mm	mm	mm	kg/m <sup>3</sup>	cm <sup>2</sup>	cm	cm	cm	cm	cm	cm <sup>4</sup>	cm <sup>3</sup>	cm	cm <sup>4</sup>	cm <sup>3</sup>	cm	cm <sup>4</sup>	cm	cm <sup>4</sup>	cm	mm	mm	mm	x10 <sup>-2</sup> m <sup>2</sup> /m <sup>3</sup>	m <sup>2</sup> /t		
120	80	8	12.20	15.50	3.83	1.87	8.23	5.99	3.27	4.20	0.441	226	27.6	3.82	80.8	13.2	2.29	261	4.10	45.8	1.72	45	85	M20	39.10	32.00
		10	15.00	19.10	3.92	1.95	8.18	6.03	3.37	4.19	0.438	276	34.1	3.80	98.1	16.2	2.27	318	4.07	56.1	1.71	45	85	M20	39.10	26.10
		12	17.80	22.70	4.00	2.03	8.14	6.06	3.46	4.18	0.433	323	40.4	3.77	114	19.1	2.25	371	4.04	66.1	1.71	45	85	M20	39.10	22.00
		14	20.50	26.20	4.08	2.10	8.10	6.08	3.55	4.17	0.429	368	46.4	3.75	130	22.0	2.23	421	4.01	75.8	1.70	45	85	M20	39.10	19.07
130	65	8	11.90	15.10	4.56	1.37	8.50	5.71	2.49	3.86	0.263	263	31.1	4.17	44.8	8.7	1.72	280	4.31	28.6	1.38	50	90	M20	38.10	32.00
		10	14.60	18.60	4.65	1.45	8.43	5.76	2.58	3.82	0.259	321	38.4	4.15	54.2	10.7	1.71	340	4.27	35.0	1.37	50	90	M20	38.10	26.10
		12	17.30	22.10	4.74	1.53	8.37	5.81	2.66	3.80	0.255	376	45.5	4.12	63.0	12.7	1.69	397	4.24	41.2	1.37	50	90	M20	38.10	22.00
130	90	10	16.60	21.20	4.15	2.18	8.92	6.69	3.75	4.62	0.472	358	40.5	4.11	141	20.6	2.58	420	4.46	78.5	1.93	50	90	M20	42.97	25.88
		12	19.70	25.10	4.84	2.26	8.88	6.72	3.85	4.60	0.463	420	48.0	4.09	165.0	24.4	2.56	492	4.43	92.6	1.92	50	90	M20	42.97	21.81
150	75	9	15.30	19.50	5.28	1.57	9.79	6.62	2.90	4.46	0.265	455	46.8	4.83	78.3	13.2	2.00	484	4.98	50.0	1.60	60	110	M24	44.10	28.80
		11	18.60	23.60	5.37	1.65	9.73	6.66	2.97	4.44	0.261	545	56.6	4.80	93.0	15.9	1.98	578	4.95	59.8	1.59	60	110	M24	44.10	23.00
150	100	10	19.00	24.20	4.80	2.34	10.30	7.50	4.10	5.25	0.442	552	54.1	4.78	198	25.8	2.86	637	5.13	112	2.15	60	110	M24	48.90	25.70
		12	22.60	28.70	4.89	2.42	10.20	7.53	4.19	5.24	0.439	650	64.2	4.76	232	30.6	2.84	749	5.10	133	2.15	60	110	M24	48.90	21.60
		14	26.10	33.20	4.97	2.50	10.20	7.56	4.28	5.23	0.435	744	74.1	4.73	264	35.2	2.82	856	5.07	152	2.14	60	110	M24	48.90	18.70
160	80	10	18.20	23.20	5.63	1.69	10.50	7.06	3.07	4.76	0.263	611	58.9	5.14	104	16.5	2.12	648	5.29	67.0	1.70	60	120	M27	46.90	25.70
		12	21.60	27.50	5.72	1.77	10.40	7.10	3.15	4.75	0.259	720	70.0	5.11	122	19.6	2.10	763	5.26	78.9	1.69	60	120	M27	46.90	21.70
		14	25.00	31.80	5.81	1.85	10.30	7.16	3.23	4.72	0.256	823	80.7	5.09	139	22.5	2.09	871	5.23	90.5	1.69	60	120	M27	46.90	18.70
180	90	10	20.60	26.20	6.28	1.85	11.80	7.89	3.38	5.42	0.262	880	75.1	5.80	151	21.1	2.40	934	5.97	97.4	1.93	65	135	M27	52.80	25.63
		12	24.50	31.20	6.37	1.93	11.70	7.95	3.48	5.38	0.261	1040	89.3	5.77	177	25.1	2.38	1100	5.94	114	1.92	65	135	M27	52.80	21.55
		14	28.30	36.10	6.46	2.01	11.70	8.01	3.57	5.34	0.259	1190	103	5.75	202	28.9	2.37	1260	5.92	131	1.91	65	135	M27	52.80	18.65
200	100	10	23.00	29.20	6.93	2.01	13.20	8.76	3.75	5.98	0.266	1220	93.2	6.46	210	26.3	2.68	1300	6.66	133	2.14	65	150	M27	58.70	25.50
		12	27.30	34.80	7.03	2.10	13.10	8.82	3.84	5.95	0.264	1440	111	6.43	247	31.3	2.67	1530	6.63	158	2.13	65	150	M27	58.70	21.50
		14	31.60	40.30	7.12	2.18	13.00	8.88	3.93	5.92	0.262	1650	128	6.41	282	36.1	2.65	1760	6.60	181	2.13	65	150	M27	58.70	18.60
		16	35.90	45.70	7.20	2.26	12.90	8.93	4.02	5.88	0.259	1860	145	6.38	316	40.8	2.63	1970	6.57	204	2.11	65	150	M27	58.70	16.35



# CHANNEL (U.P.N.)

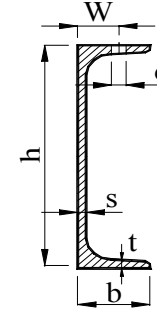
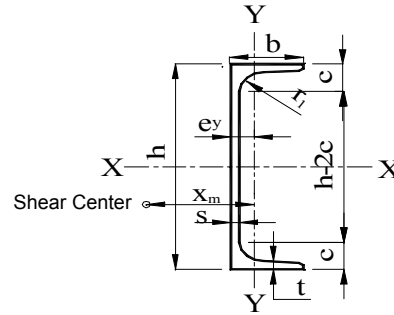

Sec. No.	Weight kg/m`	Area cm <sup>2</sup>	A <sub>web</sub> cm <sup>2</sup>	Dimensions								Axis X-X			Axis Y-Y			Details		Surface Area	
				h mm	b mm	s mm	t=r <sub>1</sub> mm	c mm	h-2c mm	e <sub>y</sub> cm	X <sub>m</sub> cm	I <sub>x</sub> cm <sup>4</sup>	S <sub>x</sub> cm <sup>3</sup>	r <sub>x</sub> cm	I <sub>y</sub> cm <sup>4</sup>	S <sub>y</sub> cm <sup>3</sup>	r <sub>y</sub> cm	W mm	d <sub>max</sub> mm	U <sub>m</sub> x10 <sup>-2</sup> m <sup>2</sup> /m <sup>1</sup>	U <sub>t</sub> m <sup>2</sup> /t
30x15	1.74	2.21	0.84	30	15	4.0	4.5	9.0	12	0.52	0.74	2.53	1.69	1.07	0.38	0.39	0.42	N.A.	N.A.	7.14	41.00
30	4.27	5.44	0.80	30	33	5.0	7.0	14.5	1	1.31	2.22	6.39	4.26	1.08	5.33	2.68	0.99	N.A.	N.A.	17.40	40.74
40x20	2.87	3.66	1.45	40	20	5.0	5.5	11.0	18	0.67	1.01	7.58	3.79	1.44	1.14	0.86	0.56	N.A.	N.A.	13.71	47.77
40	4.87	6.21	1.30	40	35	5.0	7.0	14.5	11	1.33	2.32	14.1	7.05	1.50	6.68	3.08	1.04	N.A.	N.A.	19.47	40.00
50x25	3.86	4.92	1.90	50	25	5.0	6.0	12.5	25	0.81	1.34	16.6	6.73	1.85	2.49	1.48	0.71	N.A.	N.A.	17.52	45.40
50	5.59	7.12	1.80	50	38	5.0	7.0	15.0	20	1.37	2.47	26.4	10.6	1.92	9.12	3.75	1.13	N.A.	N.A.	22.40	40.06
60	5.07	6.46	2.88	60	30	6.0	6.0	12.5	35	0.91	1.50	31.6	10.5	2.21	4.51	2.16	0.84	N.A.	N.A.	21.32	42.06
65	7.09	9.03	2.75	65	42	5.5	7.5	16.0	33	1.42	2.60	57.5	17.7	2.52	14.1	5.07	1.25	22	M10	27.30	38.50
70	6.73	8.57	3.42	70	40	6.0	6.5	16.0	38	1.42	2.20	61.1	17.5	2.67	11.4	4.10	1.15	22	M10	26.67	39.64
80	8.64	11.00	3.84	80	45	6.0	8.0	17.0	47	1.45	2.67	106	26.5	3.10	19.4	6.36	1.33	25	M12	31.20	36.10
100	10.60	13.50	4.98	100	50	6.0	8.5	18.0	64	1.55	2.93	206	41.2	3.91	29.3	8.49	1.47	30	M12	37.20	35.10
120	13.40	17.00	7.14	120	55	7.0	9.0	19.0	82	1.60	3.03	364	60.7	4.62	43.2	11.1	1.59	30	M16	43.40	32.40
140	16.00	20.40	8.40	140	60	7.0	10.0	21.0	97	1.75	3.37	605	86.4	5.45	62.7	14.8	1.75	35	M16	48.90	30.60
160	18.80	24.00	10.43	160	65	7.5	10.5	22.5	116	1.84	3.56	925	116	6.21	85.3	18.3	1.89	35	M20	54.60	29.00
180	22.00	28.00	12.64	180	70	8.0	11.0	23.5	133	1.92	3.75	1350	150	6.95	114	22.4	2.02	40	M20	61.10	37.80
200	25.30	32.20	15.05	200	75	8.5	11.5	24.5	151	2.01	3.94	1910	191	7.70	148	27.0	2.14	40	M20	66.10	26.10
220	29.40	37.40	17.55	220	80	9.0	12.5	26.5	166	2.14	4.20	2690	245	8.48	197	33.6	2.30	45	M20	71.80	24.40
240	33.20	42.30	20.33	240	85	9.5	13.0	28.0	185	2.23	4.39	3600	300	9.22	248	39.6	2.42	45	M24	77.50	23.30
260	37.90	48.30	23.20	260	90	10.0	14.0	30.0	201	2.36	4.66	4820	371	9.99	317	47.7	2.56	50	M24	83.40	22.00
280	41.80	53.30	25.00	280	95	10.0	15.0	32.0	213	2.53	5.02	6280	448	10.90	399	57.2	2.74	50	M24	89.00	21.00
300	46.20	58.80	26.80	300	100	10.0	16.0	34.0	232	2.70	5.41	8030	535	11.70	495	67.8	2.90	55	M27	95.00	20.60
320	59.50	75.80	39.90	320	100	14.0	17.5	37.0	247	2.60	4.82	10870	679	12.10	597	80.6	2.81	58	M27	98.20	16.50
350	60.60	77.30	44.52	350	100	14.0	16.0	34.0	283	2.40	4.45	12840	734	12.90	570	75.0	2.72	58	M27	105.00	17.30
380	63.10	80.40	46.98	380	102	13.5	16.0	33.5	313	2.38	4.58	15760	829	14.00	615	78.7	2.77	60	M27	111.00	17.70
400	71.80	91.50	50.96	400	110	14.0	18.0	38.0	325	2.65	5.11	20350	1020	14.90	846	102	3.04	60	M27	118.00	16.50

N.A.=not available for this channel size

# STANDARD I - BEAMS ( I.P.N. )

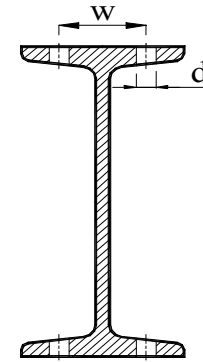
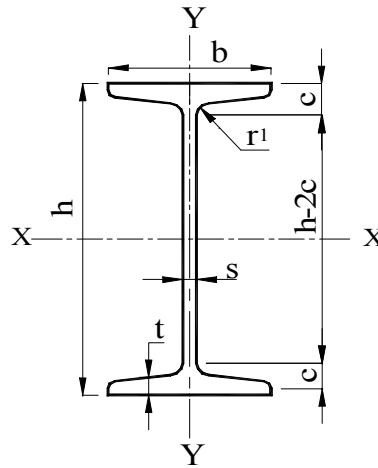

Sec. No.	Weight kg/m`	Area cm <sup>2</sup>	A <sub>web</sub> cm <sup>2</sup>	Dimensions						Axis X-X			Axis Y-Y			Details		Surface Area	
				h mm	b mm	s=r <sub>1</sub> mm	t mm	c mm	h-2c mm	I <sub>x</sub> cm <sup>4</sup>	S <sub>x</sub> cm <sup>3</sup>	r <sub>x</sub> cm	I <sub>y</sub> cm <sup>4</sup>	S <sub>y</sub> cm <sup>3</sup>	r <sub>y</sub> cm	w mm	d <sub>max</sub> mm	U <sub>m</sub> x10 <sup>-2</sup> m <sup>2</sup> /m <sup>1</sup>	U <sub>t</sub> m <sup>2</sup> /t
80	5.94	7.57	2.66	80	42	3.9	5.9	10.5	59	77.8	19.5	3.20	6.29	3.00	0.91	N.A.		30.40	51.20
100	8.34	10.60	3.89	100	50	4.5	6.8	12.5	75	171	34.2	4.01	12.2	4.88	1.07	N.A.		37.00	44.40
120	11.10	14.20	5.33	120	58	5.1	7.7	14	92	328	54.7	4.81	21.5	7.41	1.23	N.A.		43.90	39.50
140	14.30	18.20	7.00	140	66	5.7	8.6	15.5	109	573	81.9	5.61	35.2	10.7	1.40	34	M10	50.20	35.10
160	17.90	22.80	8.88	160	74	6.3	9.5	17.5	125	935	117	6.40	54.7	14.8	1.55	40	M10	57.50	32.10
180	21.90	27.90	10.98	180	82	6.9	10.4	19	142	1450	161	7.20	81.3	19.8	1.71	44	M12	64.00	29.20
200	26.20	33.40	13.31	200	90	7.5	11.3	20.5	159	2140	214	8.00	117	26.0	1.87	48	M12	70.90	27.00
220	31.10	39.50	15.84	220	98	8.1	12.2	22	176	3060	278	8.80	162	33.1	2.02	52	M12	77.50	24.90
240	36.20	46.10	18.60	240	106	8.7	13.1	24	192	4250	354	9.59	221	41.7	2.20	56	M16	84.40	23.30
260	41.90	53.30	21.79	260	113	9.4	14.1	26	208	5740	442	10.40	288	51.0	2.32	60	M16	90.60	21.60
280	47.90	61.00	25.21	280	119	10.1	15.2	27.5	225	7590	542	11.10	364	61.2	2.45	60	M16	96.60	20.10
300	54.20	69.00	28.90	300	125	10.8	16.2	29.5	241	9800	653	11.90	451	72.2	2.56	64	M20	103.00	19.00
320	61.00	77.70	32.82	320	131	11.5	17.3	31	258	12510	782	12.70	555	84.7	2.67	70	M20	109.00	17.90
340	68.00	86.70	37.01	340	137	12.2	18.3	33	274	15700	923	13.50	674	98.4	2.80	74	M20	115.00	16.90
360	76.10	97.00	41.73	360	143	13	19.5	35	290	19610	1090	14.20	818	114	2.90	76	M20	121.00	15.90
380	84.00	107.00	46.44	380	149	13.7	20.5	37	306	24010	1260	15.00	975	131	3.02	82	M20	127.00	15.10
400	92.40	118.00	51.38	400	s	14.4	21.6	38.5	323	29210	1460	15.70	1160	149	3.13	86	M20	133.00	14.40
425	104.00	132.00	57.99	425	163	15.3	23	41	343	36970	1740	16.70	1440	176	3.30	88	M20	144.40	13.50
450	115.00	147.00	65.03	450	170	16.2	24.3	43.5	363	45850	2040	17.70	1730	203	3.43	94	M24	148.00	12.90
475	128.00	163.00	72.47	475	178	17.1	25.6	45.5	384	56480	2380	18.60	2090	235	3.60	100	M24	155.10	12.11
500	141.00	179.00	80.28	500	185	18	27	48	404	68740	2750	19.60	2480	268	3.72	100	M27	163.00	11.50
550	166.00	212.00	93.10	550	200	19	30	52.5	445	99180	3610	21.60	3490	349	4.02	110	M27	177.30	10.68
600	199.00	254.00	115.60	600	215	21.6	32.4	57.5	485	139000	4630	23.40	4670	434	4.30	120	M27	191.90	9.64

N.A.=not available for this IPN size

# I.P.E.

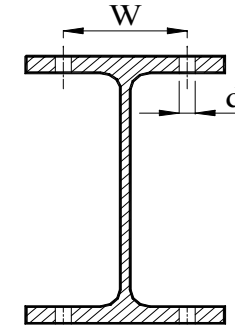
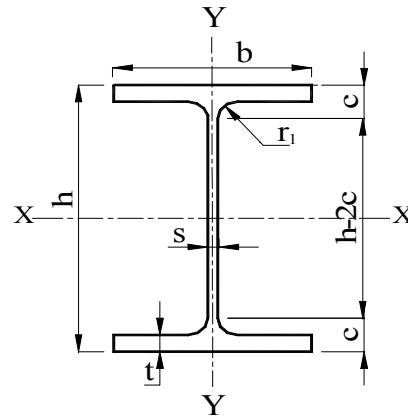

Sec. No.	Weight kg/m	Area cm <sup>2</sup>	A <sub>web</sub> cm <sup>2</sup>	Dimensions							Axis X-X			Axis Y-Y			Details		Surface Area	
				h mm	b mm	s mm	t mm	r <sub>1</sub> mm	c mm	h-2c mm	I <sub>x</sub> cm <sup>4</sup>	S <sub>x</sub> cm <sup>3</sup>	r <sub>x</sub> cm	I <sub>y</sub> cm <sup>4</sup>	S <sub>y</sub> cm <sup>3</sup>	r <sub>y</sub> cm	w mm	d <sub>max</sub> mm	U <sub>m</sub> x10 <sup>-2</sup> m <sup>2</sup> /m <sup>l</sup>	U <sub>t</sub> m <sup>2</sup> /t
80	6.00	7.64	2.64	80	46	3.8	5.2	5	10.2	59.6	80.1	20.0	3.24	8.49	3.69	1.05	N.A.	N.A.	32.80	54.80
100	8.10	10.30	3.63	100	55	4.1	5.7	7	12.7	74.6	171	34.2	4.07	15.9	5.79	1.24	N.A.	N.A.	40.00	49.50
120	10.40	13.20	4.73	120	64	4.4	6.3	7	13.3	93.4	318	53.0	4.90	27.7	8.65	1.45	36	M10	47.50	45.60
140	12.90	16.40	5.93	140	73	4.7	6.9	7	13.9	112.2	541	77.3	5.74	44.9	12.3	1.65	38	M10	55.10	42.60
160	15.80	20.10	7.26	160	82	5.0	7.4	9	16.4	127.2	869	109	6.58	68.3	16.7	1.84	44	M12	62.30	39.40
180	18.80	23.90	8.69	180	91	5.3	8.0	9	17.0	146.0	1320	146	7.42	101	22.2	2.05	50	M12	69.80	37.10
200	22.40	28.50	10.25	200	100	5.6	8.5	12	20.5	159.0	1940	194	8.26	142	28.5	2.24	56	M12	76.80	34.30
220	26.20	33.40	11.89	220	110	5.9	9.2	12	21.2	177.6	2770	252	9.11	205	37.3	2.48	60	M16	84.80	32.40
240	30.70	39.10	13.66	240	120	6.2	9.8	15	24.8	190.4	3890	324	9.97	284	47.3	2.69	68	M16	92.20	30.00
270	36.10	45.90	16.47	270	135	6.6	10.2	15	25.2	219.6	5790	429	11.20	420	62.2	3.02	72	M20	104.00	28.80
300	42.20	53.80	19.78	300	150	7.1	10.7	15	25.7	248.6	8360	557	12.50	604	80.5	3.35	80	M20	116.00	27.50
330	49.10	62.60	23.03	330	160	7.5	11.5	18	29.5	271.0	11770	713	13.70	788	98.5	3.55	86	M24	125.00	25.50
360	57.10	72.70	26.77	360	170	8.0	12.7	18	30.7	298.6	16270	904	15.00	1040	123	3.79	90	M24	135.00	23.60
400	66.30	84.50	32.08	400	180	8.6	13.5	21	34.5	331.0	23130	1160	16.50	1320	146	3.95	96	M27	147.00	22.20
450	77.60	98.80	39.56	450	190	9.4	14.6	21	35.6	378.8	33740	1500	18.50	1680	176	4.12	106	M27	161.00	20.70
500	90.70	116.00	47.74	500	200	10.2	16.0	21	37.0	426.0	48200	1930	20.40	2140	214	4.31	110	M27	174.00	19.20
550	106.00	134.00	57.23	550	210	11.1	17.2	24	41.2	467.6	67120	2440	22.30	2670	254	4.45	120	M27	188.00	17.70
600	122.00	156.00	67.44	600	220	12.0	19.0	24	43.0	514.0	92080	3070	24.30	3390	308	4.66	120	M27	202.00	16.60

N.A.=not available for this IPE size

# BROAD FLANGE I - BEAMS ( H.E.A. )

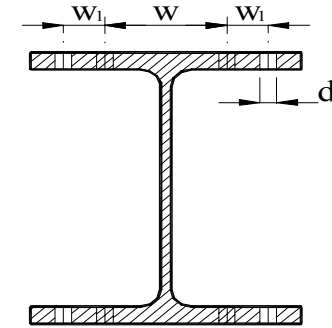
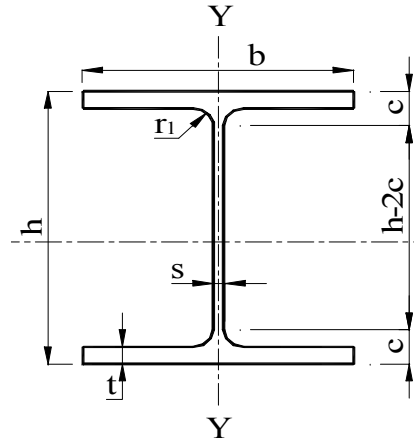

Sec. No.	Weight kg/m	Area cm <sup>2</sup>	A <sub>web</sub> cm <sup>2</sup>	Dimensions							Axis X-X			Axis Y-Y			Details			Surface Area	
				h mm	b mm	s mm	t mm	r <sub>1</sub> mm	c mm	h-2c mm	I <sub>x</sub> cm <sup>4</sup>	S <sub>x</sub> cm <sup>3</sup>	r <sub>x</sub> cm	I <sub>y</sub> cm <sup>4</sup>	S <sub>y</sub> cm <sup>3</sup>	r <sub>y</sub> cm	w mm	w <sub>1</sub> mm	d <sub>max</sub> mm	U <sub>m</sub> x10 <sup>-2</sup> m <sup>2</sup> /m	U <sub>t</sub> m <sup>2</sup> /t
100	16.7	21.2	4.00	96	100	5.0	8.0	12	20	56	349	73	4.06	134	26.8	2.51	56	N.A.	M12	56.10	33.60
120	19.9	25.3	4.90	114	120	5.0	8.0	12	20	74	606	106	4.89	231	38.5	3.02	66	N.A.	M16	67.70	34.00
140	24.7	31.4	6.38	133	140	5.5	8.5	12	21	91	1030	155	5.73	389	55.6	3.52	76	N.A.	M20	79.40	32.10
160	30.4	38.8	8.04	152	160	6.0	9.0	15	24	104	1670	220	6.57	616	76.9	3.98	86	N.A.	M20	90.60	29.80
180	35.5	45.3	9.12	171	180	6.0	9.5	15	25	121	2510	294	7.45	925	103	4.52	100	N.A.	M24	102.00	28.70
200	42.3	53.8	11.05	190	200	6.5	10.0	18	28	134	3690	389	8.28	1340	134	4.98	110	N.A.	M24	114.00	26.90
220	50.5	64.3	13.16	210	220	7.0	11.0	18	29	152	5410	515	9.17	1950	178	5.51	120	N.A.	M24	126.00	24.90
240	60.3	76.8	15.45	230	240	7.5	12.0	21	33	164	7760	675	10.10	2770	231	6.00	90	40	M24	137.00	22.70
260	68.2	86.8	16.88	250	260	7.5	12.5	24	37	176	10450	836	11.00	3670	282	6.50	95	40	M24	148.00	21.70
280	76.4	97.3	19.52	270	280	8.0	13.0	24	37	196	13670	1010	11.90	4760	340	7.00	110	40	M24	160.00	21.00
300	88.3	113	22.27	290	300	8.5	14.0	27	41	208	18260	1260	12.70	6310	421	7.49	120	50	M27	172.00	19.50
320	97.6	124	25.11	310	300	9.0	15.5	27	43	224	22930	1480	13.60	6990	466	7.49	120	50	M27	176.00	18.00
340	105	133	28.22	330	300	9.5	16.5	27	44	242	27690	1680	14.40	7440	496	7.46	120	50	M27	179.00	17.10
360	112	143	31.50	350	300	10.0	17.5	27	45	260	33090	1890	15.20	7890	526	7.43	120	50	M27	183.00	16.40
400	125	159	38.72	390	300	11.0	19.0	27	46	298	45070	2310	16.80	8560	571	7.34	120	50	M27	191.00	15.30
450	140	178	45.77	440	300	11.5	21.0	27	48	344	63720	2900	18.90	9470	631	7.29	120	50	M27	201.00	14.40
500	155	198	53.28	490	300	12.0	23.0	27	50	390	86970	3550	21.00	10370	691	7.24	120	50	M27	211.00	13.60
550	166	212	61.50	540	300	12.5	24.0	27	51	438	111900	4150	23.00	10820	721	7.15	120	50	M27	221.00	13.30
600	178	226	70.20	590	300	13.0	25.0	27	52	486	141200	4790	25.00	11270	751	7.05	120	50	M27	231.00	13.00
650	190	242	79.38	640	300	13.5	26.0	27	53	534	175200	5470	26.90	11720	782	6.97	120	50	M27	241.00	12.70
700	204	260	92.22	690	300	14.5	27.0	27	54	582	215300	6240	28.80	12180	812	6.84	120	50	M27	250.00	12.30
800	224	286	110.10	790	300	15.0	28.0	30	58	674	303400	7680	32.60	12640	843	6.65	120	50	M27	270.00	12.00
900	252	321	132.80	890	300	16.0	30.0	30	60	770	422100	9480	36.30	13550	903	6.50	120	50	M27	290.00	11.50
1000	272	347	153.12	990	300	16.5	31.0	30	61	868	553800	11190	40.00	14000	934	6.35	120	50	M27	310.00	11.40

N.A. =not available for this HEA size

# BROAD FLANGE I - BEAMS ( H.E.B. )

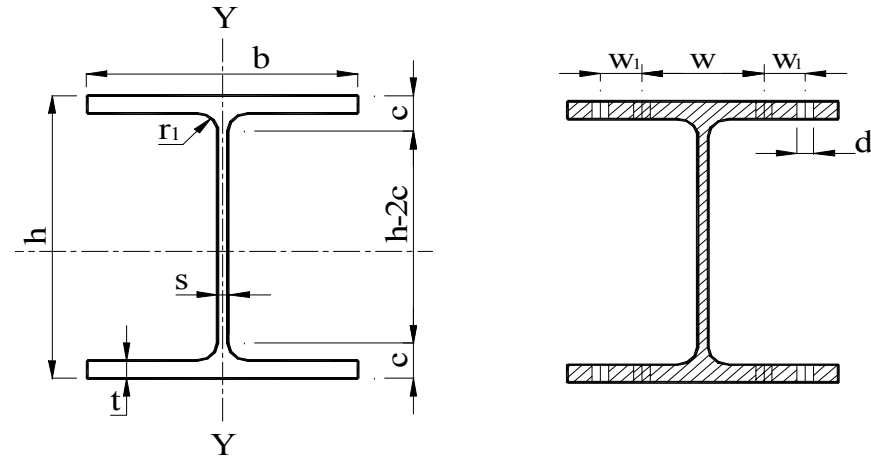

Sec. No.	Weight kg/m	Area cm <sup>2</sup>	A <sub>web</sub> cm <sup>2</sup>	Dimensions							Axis X-X			Axis Y-Y			Details			Surface Area	
				h mm	b mm	s mm	t mm	r <sub>1</sub> mm	c mm	h-2c mm	I <sub>x</sub> cm <sup>4</sup>	S <sub>x</sub> cm <sup>3</sup>	r <sub>x</sub> cm	I <sub>y</sub> cm <sup>4</sup>	S <sub>y</sub> cm <sup>3</sup>	r <sub>y</sub> cm	w mm	w <sub>1</sub> mm	d <sub>max</sub> mm	U <sub>m</sub> x10 <sup>-2</sup> m <sup>2</sup> /m	U <sub>t</sub> m <sup>2</sup> /t
100	20.4	26.0	4.80	100	100	6.0	10.0	12	22.0	56	450	89.9	4.16	167	33.5	2.53	56	N.A.	M12	56.70	27.80
120	26.7	34.0	6.37	120	120	6.5	11.0	12	23.0	74	864	144	5.04	318	52.9	3.06	66	N.A.	M16	68.60	25.70
140	33.7	43.0	8.12	140	140	7.0	12.0	12	24.0	92	1510	216	5.93	550	78.5	3.58	76	N.A.	M20	80.50	23.80
160	42.6	54.3	10.72	160	160	8.0	13.0	15	28.0	104	2490	311	6.78	889	111	4.05	86	N.A.	M20	91.80	21.50
180	51.2	65.3	12.92	180	180	8.5	14.0	15	29.0	122	3830	426	7.66	1360	151	4.57	100	N.A.	M24	104.00	20.30
200	61.3	78.1	15.30	200	200	9.0	15.0	18	33.0	134	5700	570	8.54	2000	200	5.07	110	N.A.	M24	115.00	18.80
220	71.5	91.0	17.86	220	220	9.5	16.0	18	34.0	152	8090	736	9.43	2840	258	5.59	120	N.A.	M24	127.00	17.80
240	83.2	106	20.60	240	240	10.0	17.0	21	38.0	164	11260	938	10.30	3920	327	6.08	90	40	M20	138.00	16.60
260	93.0	118	22.50	260	260	10.0	17.5	24	41.5	177	14920	1150	11.20	5130	395	6.58	95	40	M20	150.00	16.10
280	103	131	25.62	280	280	10.5	18.0	24	42.0	196	19270	1380	12.10	6590	471	7.09	110	40	M20	162.00	15.70
300	117	149	28.82	300	300	11.0	19.0	27	46.0	208	25170	1680	13.00	8560	571	7.58	120	50	M24	173.00	14.80
320	127	161	32.09	320	300	11.5	20.5	27	47.5	225	30820	1930	13.80	9240	616	7.57	120	50	M24	177.00	13.90
340	134	171	35.64	340	300	12.0	21.5	27	48.5	243	36660	2160	14.60	9690	646	7.53	120	50	M24	181.00	13.50
360	142	181	39.38	360	300	12.5	22.5	27	49.5	261	43190	2400	15.50	10140	676	7.49	120	50	M24	185.00	13.00
400	155	198	47.52	400	300	13.5	24.0	27	51.0	298	57680	2880	17.10	10820	721	7.40	120	50	M24	193.00	12.40
450	171	218	55.72	450	300	14.0	26.0	27	53.0	344	79890	3550	19.10	11720	781	7.33	120	50	M24	203.00	11.90
500	187	239	64.38	500	300	14.5	28.0	27	55.0	390	107200	4290	21.20	12620	842	7.27	120	50	M24	212.00	11.30
550	199	254	73.80	550	300	15.0	29.0	27	56.0	438	136700	4970	23.20	13080	872	7.17	120	50	M24	222.00	12.20
600	212	270	83.70	600	300	15.5	30.0	27	57.0	486	171000	5700	25.20	13530	902	7.08	120	50	M24	232.00	11.00
650	225	286	94.08	650	300	16.0	31.0	27	58.0	534	210600	6480	27.10	13980	932	6.99	120	50	M24	242.00	10.80
700	241	306	108.1	700	300	17.0	32.0	27	59.0	582	256900	7340	29.00	14440	963	6.87	120	50	M24	252.00	10.50
800	262	334	128.5	800	300	17.5	33.0	30	63.0	674	359100	9890	32.80	14900	994	6.68	120	50	M24	271.00	10.40
900	291	371	153.6	900	300	18.5	35.0	30	65.0	770	494100	10980	36.50	15820	1050	6.53	120	50	M24	291.00	10.00
1000	314	400	176.3	1000	300	19.0	36.0	30	66.0	868	644700	12890	40.10	16280	1090	6.38	120	50	M24	311.00	9.90

N.A.=not available for this HEB size

# BROAD FLANGE I - BEAMS ( H.E.M. )

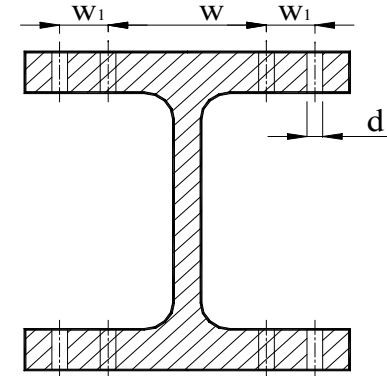
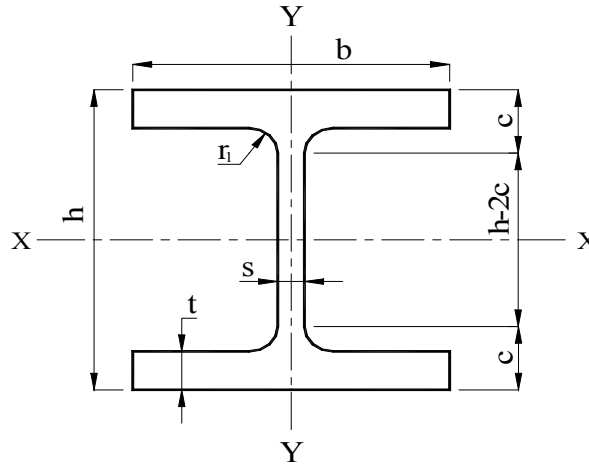

Sec. No.	Weight kg/m`	Area cm <sup>2</sup>	A <sub>web</sub> cm <sup>2</sup>	Dimensions							Axis X-X			Axis Y-Y			Details			Surface Area	
				h mm	b mm	s mm	t mm	r <sub>1</sub> mm	c mm	h-2c mm	I <sub>x</sub> cm <sup>4</sup>	S <sub>x</sub> cm <sup>3</sup>	r <sub>x</sub> cm	I <sub>y</sub> cm <sup>4</sup>	S <sub>y</sub> cm <sup>3</sup>	r <sub>y</sub> cm	w mm	w <sub>1</sub> mm	d <sub>max</sub> mm	U <sub>m</sub> x10 <sup>-2</sup> m <sup>2</sup> /m <sup>1</sup>	U <sub>t</sub> m <sup>2</sup> /t
100	41.8	53.2	9.60	120	106	12	20	12	32	56	1140	190	4.63	400	75.3	2.74	60	N.A.	M12	61.90	14.80
120	52.1	66.4	12.25	140	126	12.5	21	12	33	74	2020	288	5.51	700	112	3.25	68	N.A.	M16	73.80	14.20
140	63.2	80.6	15.08	160	146	13	22	12	34	92	3290	411	6.39	1140	157	3.77	76	N.A.	M20	85.70	13.60
160	76.2	97.1	18.76	180	166	14	23	15	38	104	5100	566	7.25	1760	212	4.26	86	N.A.	M20	97.00	12.70
180	88.9	113	22.04	200	186	14.5	24	15	39	122	7480	748	8.13	2580	277	4.77	100	N.A.	M24	109.00	12.30
200	103	131	25.50	220	206	15	25	18	43	134	10640	967	9.00	3650	354	5.27	110	N.A.	M24	120.00	11.70
220	117	149	29.14	240	226	15.5	26	18	44	152	14600	1220	9.89	5010	444	5.79	120	N.A.	M24	132.00	11.30
240	157	200	37.08	270	248	18	32	21	53	164	24290	1800	11.00	8150	657	6.39	100	40	M20	146.00	9.30
260	172	220	40.50	290	268	18	32.5	24	57	176	31310	2160	11.90	10450	780	6.90	110	40	M20	157.00	9.13
280	189	240	22.76	310	288	18.5	33	24	66	196	39550	2550	12.80	13160	914	7.40	116	40	M20	169.00	8.94
300	238	303	55.02	340	310	21	39	27	67	208	59200	3480	14.00	19400	1250	8.00	120	50	M24	183.00	7.70
320	245	312	58.59	359	309	21	40	27	67	225	68130	3800	14.80	19710	1280	7.95	126	50	M24	187.00	7.63
340	248	316	62.37	377	309	21	40	27	67	243	76370	4050	15.60	19710	1280	7.90	126	50	M24	190.00	7.67
360	250	319	66.15	395	308	21	40	27	67	261	84870	4300	16.30	19520	1270	7.83	126	50	M24	193.00	7.77
400	256	326	73.92	432	307	21	40	27	67	298	104100	4820	17.90	19340	1260	7.70	126	50	M24	200.00	7.81
450	263	335	83.58	478	307	21	40	27	67	344	131500	5500	19.80	19340	1260	7.59	126	50	M24	210.00	7.97
500	270	344	93.24	524	306	21	40	27	67	390	161900	6180	21.70	19150	1250	7.46	130	50	M24	218.00	8.07
550	278	354	103.32	572	306	21	40	27	67	438	198000	6920	23.60	19150	1250	7.35	130	50	M24	228.00	8.20
600	285	364	113.40	620	305	21	40	27	67	486	237400	7660	25.60	18980	1240	7.22	130	50	M24	237.00	8.32
650	293	374	123.48	668	305	21	40	27	67	534	281700	8430	27.50	18980	1240	7.13	130	50	M24	247.00	8.42
700	301	383	133.56	716	304	21	40	27	67	582	329300	9200	29.30	18800	1240	7.01	130	50	M24	256.00	8.50
800	317	404	154.14	814	303	21	40	30	70	674	442600	10870	33.10	18630	1230	6.79	132	50	M24	275.00	8.66
900	333	424	174.30	910	302	21	40	30	70	770	570400	12540	36.70	18450	1220	6.60	132	50	M24	293.00	8.80
1000	349	444	194.88	1008	302	21	40	30	70	868	722300	14330	40.30	18450	1220	6.45	132	50	M24	313.00	8.97

N.A.=not available for this HEM size

## T - SECTION Half I.P.E.

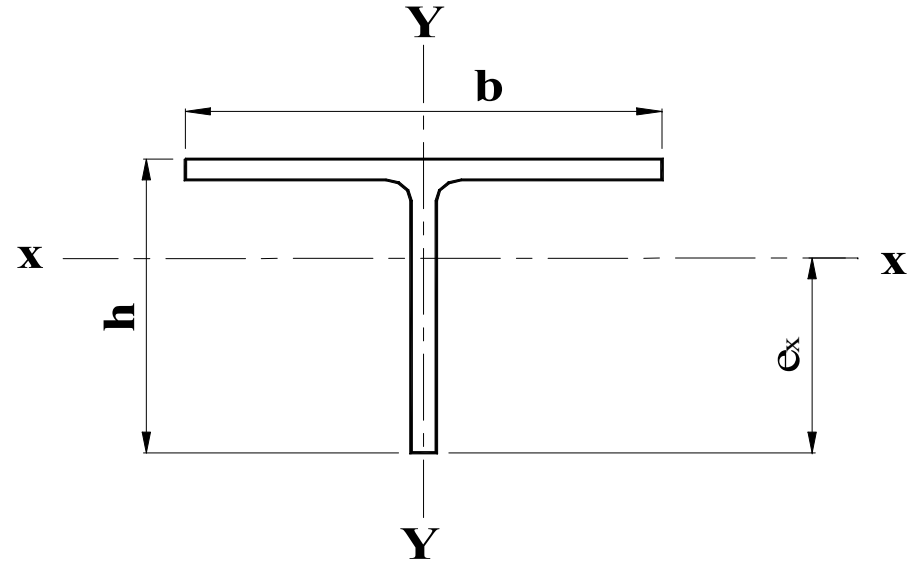

1/2 IPE No.	Weight kg/m <sup>1</sup>	Area cm <sup>2</sup>	A <sub>web</sub> cm <sup>2</sup>	Dimensions		Axis X-X					Axis Y-Y			Surface Area	
				h	b	I <sub>x</sub>	S <sub>xb</sub>	S <sub>xt</sub>	r <sub>x</sub>	e <sub>x</sub>	I <sub>y</sub>	S <sub>y</sub>	r <sub>y</sub>	U <sub>m</sub>	U <sub>t</sub>
				mm	mm	cm <sup>4</sup>	cm <sup>3</sup>	cm <sup>3</sup>	cm	cm	cm <sup>4</sup>	cm <sup>3</sup>	cm	x10 <sup>-2</sup> m <sup>2</sup> /m <sup>1</sup>	m <sup>2</sup> /m <sup>1</sup>
80	3.00	3.82	1.32	40	46	4.80	1.58	5.00	1.12	3.04	4.24	1.84	1.05	16.40	54.80
100	4.05	5.15	1.82	50	55	10.3	2.70	8.66	1.41	3.81	7.95	2.89	1.24	20.00	49.50
120	5.20	6.62	2.36	60	64	19.3	4.20	13.79	1.71	4.60	13.80	4.32	1.45	23.70	45.60
140	6.45	8.21	2.97	70	73	33.2	6.14	20.49	2.01	5.38	22.40	6.15	1.65	27.50	42.60
160	7.89	10.10	3.63	80	82	52.9	8.57	28.75	2.29	6.16	34.10	8.34	1.84	31.10	39.40
180	9.40	12.00	4.35	90	91	80.3	11.5	39.17	2.59	6.95	50.40	11.1	2.05	34.90	37.10
200	11.20	14.20	5.12	100	100	117	15.1	52.00	2.87	7.75	71.20	14.2	2.24	38.40	34.30
220	13.10	16.70	5.95	110	110	165	19.3	67.35	3.15	8.55	100.2	18.6	2.48	42.40	32.40
240	15.40	19.60	6.83	120	120	227	24.3	86.31	3.41	9.37	142.0	23.7	2.69	46.00	30.00
270	18.00	23.00	8.24	135	135	346	32.8	116.50	3.88	10.53	210.0	31.1	3.02	52.00	28.80
300	21.10	26.90	9.89	450	150	509	43.6	153.31	4.35	41.68	302.0	40.3	3.35	58.00	27.50
330	24.60	31.30	11.51	165	160	717	55.8	196.44	4.78	12.85	394.0	49.3	3.55	62.50	25.50
360	28.50	36.40	13.38	180	170	992	70.8	255.01	5.22	14.11	521.0	61.3	3.79	67.50	23.60
400	33.20	42.20	16.04	200	180	1450	93.7	320.80	5.86	15.48	659.0	73.4	3.95	73.50	22.20
450	38.80	49.40	19.78	225	190	2220	129	420.45	6.70	17.22	838.0	88.4	4.12	80.50	20.70
500	45.30	57.80	23.87	250	200	3260	172	542.43	7.52	18.99	1070	107.0	4.31	87.00	19.20
550	52.80	67.20	28.62	275	210	4670	225	689.81	8.33	20.73	1330	127.0	4.45	94.00	17.70
600	61.20	78.00	33.72	300	220	6500	288	868.98	9.13	22.52	1690	154.0	4.66	101.00	16.60

# T - SECTIONS

## Half H.E.A.

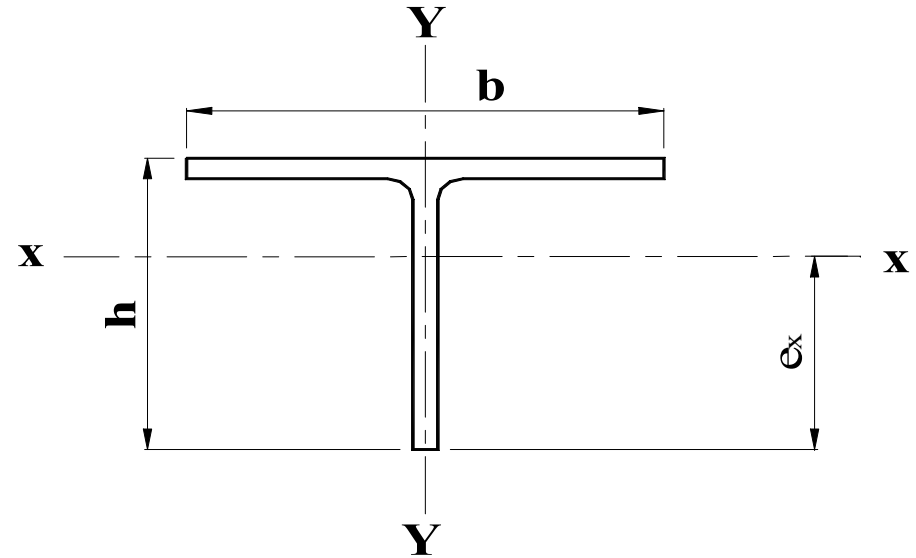

1/2 HEA No.	Weight kg/m <sup>1</sup>	Area cm <sup>2</sup>	A <sub>web</sub> cm <sup>2</sup>	Dimensions		Axis X-X					Axis Y-Y			Surface Area	
				h mm	b mm	I <sub>x</sub> cm <sup>4</sup>	S <sub>xb</sub> cm <sup>3</sup>	S <sub>xt</sub> cm <sup>3</sup>	r <sub>x</sub> cm	e <sub>x</sub> cm	I <sub>y</sub> cm <sup>4</sup>	S <sub>y</sub> cm <sup>3</sup>	r <sub>y</sub> cm	U <sub>m</sub> x10 <sup>-2</sup> m <sup>2</sup> /m <sup>1</sup>	U <sub>t</sub> m <sup>2</sup> /m <sup>1</sup>
100	8.34	10.60	2.00	48	100	12.4	3.16	13.9	1.08	3.91	67	13.4	2.51	28.00	33.60
120	9.94	12.70	2.45	57	120	21.3	4.52	21.7	1.30	4.72	115	19.2	3.02	33.80	34.00
140	12.30	15.70	3.19	66	140	37.5	6.79	33.2	1.55	5.47	194	27.8	3.52	39.70	32.10
160	15.20	19.40	4.02	76	160	61.5	9.72	48.0	1.78	6.32	308	38.5	3.98	45.30	29.80
180	17.80	22.60	4.56	85	180	89.1	12.4	65.0	1.98	7.13	462	51.4	4.52	51.00	28.70
200	21.10	26.90	5.53	95	200	133	16.6	87.5	2.22	7.98	668	66.8	4.98	57.00	26.90
220	25.30	32.20	6.58	105	220	194	21.9	116.9	2.45	8.84	975	88.8	5.51	63.00	24.90
240	30.20	38.40	7.73	115	240	273	28.8	150.8	2.67	9.69	1380	115	6.00	68.50	22.70
260	34.10	43.40	8.44	125	260	355	33.5	185.9	2.86	10.59	1830	141	6.50	74.00	21.70
280	38.20	48.60	9.76	135	280	477	41.7	231.6	3.13	11.44	2380	170	7.00	80.00	21.00
300	44.20	56.30	11.14	145	300	630	51.2	285.1	3.35	12.29	3150	210	7.49	86.00	19.50
320	48.80	62.20	12.56	155	300	808	61.7	335.3	3.60	13.09	3490	233	7.49	88.00	18.00
340	52.40	66.70	14.11	165	300	1020	73.5	386.4	3.91	13.86	3720	248	7.46	89.50	17.10
360	56.00	71.40	15.75	175	300	1270	86.7	442.5	4.22	14.63	3940	263	7.43	91.50	16.40
400	62.40	79.50	19.36	195	300	1890	118	557.5	4.88	16.11	4280	285	7.34	99.50	15.30
450	69.90	89.00	22.89	220	300	2820	156	715.7	5.62	18.06	4730	315	7.29	100.00	14.40
500	77.50	98.80	26.64	245	300	4020	201	891.4	6.38	19.99	5180	345	7.24	105.00	13.60
550	83.10	106.00	30.75	270	300	5530	253	1070	7.23	21.83	5410	360	7.15	110.00	13.30
600	88.90	113.00	35.10	295	300	7400	313	1261	8.08	23.63	5630	375	7.05	115.00	13.00



## T - SECTIONS Half H.E.B.

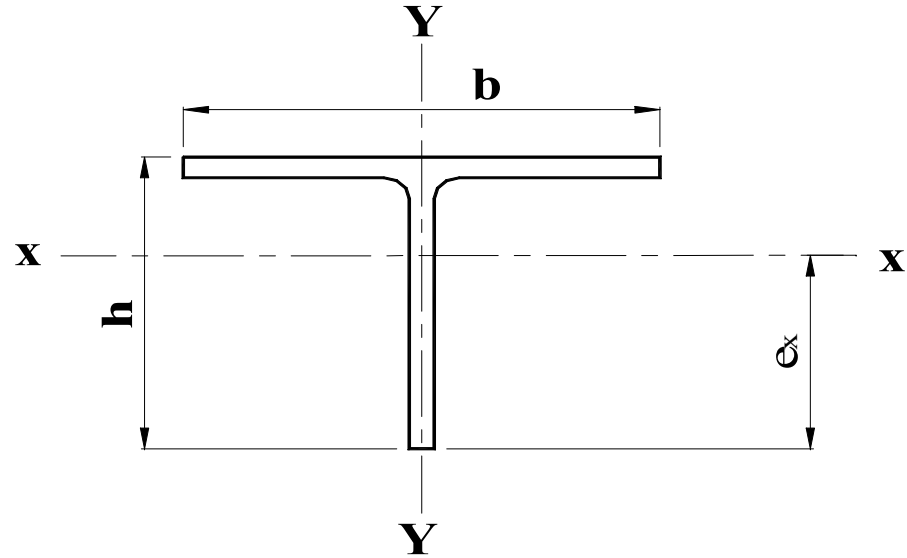

1/2 HEB No.	Weight kg/m <sup>1</sup>	Area cm <sup>2</sup>	A <sub>web</sub> cm <sup>2</sup>	Dimensions		Axis X-X					Axis Y-Y			Surface Area	
				h mm	b mm	I <sub>x</sub> cm <sup>4</sup>	S <sub>xb</sub> cm <sup>3</sup>	S <sub>xt</sub> cm <sup>3</sup>	r <sub>x</sub> cm	e <sub>x</sub> cm	I <sub>y</sub> cm <sup>4</sup>	S <sub>y</sub> cm <sup>3</sup>	r <sub>y</sub> cm	U <sub>m</sub> x10 <sup>-2</sup> m <sup>2</sup> /m <sup>1</sup>	U <sub>t</sub> m <sup>2</sup> /m <sup>1</sup>
100	10.20	13.00	2.40	50	100	16.2	4.05	16.2	1.12	4.00	84	16.8	2.53	28.30	27.80
120	13.30	17.00	3.19	60	120	30.9	6.35	27.1	1.35	4.86	159	26.4	3.06	34.30	25.70
140	16.90	21.50	4.06	70	140	53.5	9.36	41.5	1.58	5.71	275	39.2	3.58	40.20	23.90
160	21.30	27.10	5.36	80	160	91.3	14.0	61.7	1.83	6.52	444	55.5	4.05	45.90	21.50
180	25.60	32.60	6.46	90	180	139	18.9	85.8	2.07	7.38	680	75.6	4.57	52.00	20.30
200	30.60	39.00	7.65	100	200	204	24.8	115.3	2.29	8.23	1002	100	5.07	57.00	18.80
220	35.70	45.50	8.93	110	220	289	31.8	150.5	2.52	9.08	1422	129	5.59	63.50	17.80
240	41.60	53.00	10.30	120	240	397	40.0	192.7	2.74	9.94	1961	163	6.08	69.00	16.60
260	46.50	59.20	11.25	130	260	512	47.3	235.9	2.94	10.83	2570	197	6.58	75.00	16.10
280	51.60	65.70	12.81	140	280	673	57.7	290.1	3.20	11.68	3300	235	7.09	81.00	15.70
300	58.50	74.60	14.41	150	300	871	69.5	352.6	3.42	12.53	4280	285	7.58	86.50	14.80
320	63.30	80.70	16.04	160	300	1097	82.3	409.3	3.69	13.32	4620	308	7.57	88.50	13.90
340	67.10	85.40	17.82	170	300	1362	96.7	468.0	3.99	14.09	4840	323	7.53	90.50	13.50
360	70.90	90.30	19.69	180	300	1671	113	530.5	4.30	14.85	5070	338	7.49	92.50	13.00
400	77.60	98.90	23.76	200	300	2437	149	665.8	4.96	16.34	5410	360	7.40	96.50	12.40
450	85.60	109.00	27.86	225	300	3566	195	843.0	5.72	18.27	5860	390	7.33	101.00	11.90
500	93.70	119.00	32.19	250	300	5020	249	1041.5	6.49	20.18	6310	421	7.27	106.00	11.30
550	99.70	127.00	36.90	275	300	6834	311	1244.8	7.33	22.01	6540	436	7.17	111.00	11.20
600	106.00	135.00	41.85	300	300	9060	381	1461.3	8.19	23.80	6760	451	7.08	116.00	11.00

# PIPES

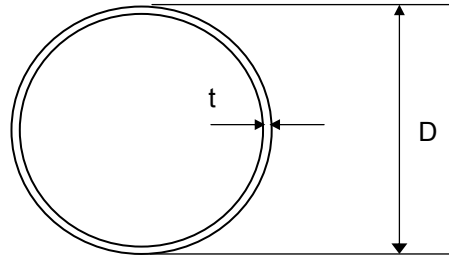

Pipe No.	Weight kg/m`	Area cm <sup>2</sup>	Dimensions		l cm <sup>4</sup>	S cm <sup>3</sup>	r cm	Surface Area	
			D	t				U <sub>m</sub>	U <sub>t</sub>
			mm	mm				x10 <sup>-2</sup> m <sup>2</sup> /m`	m <sup>2</sup> /t
38	2.59	3.30	38	3	5.00	2.68	1.24	11.94	46.09
	3.35	4.27	38	4	6.26	3.29	1.21	11.94	35.64
44.5	3.07	3.91	44.5	3	8.46	3.80	1.47	13.98	45.54
	4.00	5.09	44.5	4	10.5	4.74	1.44	13.98	34.95
	4.87	6.20	44.5	5	12.3	5.53	1.41	13.98	28.71
60	4.22	5.37	60	3	21.9	7.29	2.02	18.85	44.67
	5.52	7.04	60	4	27.7	9.24	1.99	18.85	34.15
	6.78	8.64	60	5	32.9	11.0	1.95	18.85	27.80
70	4.96	6.31	70	3	35.5	10.1	2.37	21.99	44.34
	6.51	8.29	70	4	45.3	13.0	2.34	21.99	33.78
	8.01	10.20	70	5	54.2	15.5	2.31	21.99	27.45
	9.47	12.10	70	6	62.3	17.8	2.27	21.99	23.22
76	5.40	6.88	76	3	45.9	12.1	2.58	23.88	44.21
	7.10	9.05	76	4	58.5	15.5	2.55	23.88	33.63
	8.75	11.20	76	5	70.6	18.6	2.52	23.88	27.29
	10.40	13.20	76	6	81.4	21.4	2.48	23.88	22.96
89	8.38	10.70	89	4	96.7	21.7	3.01	27.96	33.37
	10.40	13.20	89	5	117	26.2	2.98	27.96	26.88
	12.30	15.60	89	6	135	30.4	2.94	27.96	22.73
	14.20	18.00	89	7	153	34.3	2.91	27.96	19.69
108	12.70	16.20	108	5	215	39.8	3.65	33.93	26.72
	15.10	19.20	108	6	251	46.5	3.61	33.93	22.47
	17.40	22.20	108	7	285	52.7	3.58	33.93	19.50
	19.70	25.10	108	8	316	58.6	3.55	33.93	17.22
133	16.80	20.10	133	5	412	62.0	4.53	41.78	24.87
	18.80	23.90	133	6	484	72.7	4.5	41.78	22.23
	21.80	27.70	133	7	552	82.9	4.46	41.78	19.17
	24.70	31.40	133	8	616	92.6	4.43	41.78	16.92
159	19.00	24.20	159	5	718	90.3	5.45	49.95	26.29
	22.60	28.80	159	6	845	106	5.41	49.95	22.10
	26.20	33.40	159	7	967	122	5.38	49.95	19.07
	29.80	38.00	159	8	1080	136	5.35	49.95	16.76
	36.70	46.80	159	10	1300	164	5.28	49.95	13.61

# PIPES

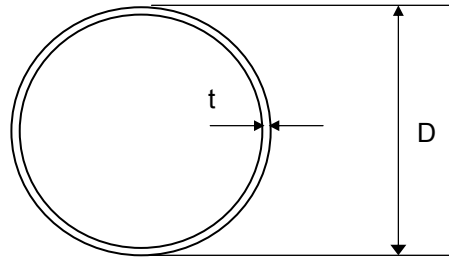

Pipe No.	Weight kg/m`	Area cm <sup>2</sup>	Dimensions		I cm <sup>4</sup>	S cm <sup>3</sup>	r cm	Surface Area	
			D	t				U <sub>m</sub>	U <sub>t</sub>
			mm	mm				x10 <sup>-2</sup> m <sup>2</sup> /m`	m <sup>2</sup> /t
194	27.8	35.4	194	6	1570	162	6.65	60.95	21.93
	32.3	41.1	194	7	1800	186	6.62	60.95	18.89
	36.7	46.7	194	8	2030	209	6.59	60.95	16.63
	45.4	57.8	194	10	2241	253	6.53	60.95	13.43
219	31.5	40.2	219	6	2280	208	7.53	68.80	21.84
	36.6	46.6	219	7	2620	240	7.50	68.80	18.81
	41.6	53.0	219	8	2960	270	7.46	68.80	16.54
	51.5	65.7	219	10	3590	328	7.40	68.80	13.36
	61.3	78.0	219	12	4190	383	7.32	68.80	11.22
245	41.1	52.3	245	7	3710	303	8.42	76.97	18.75
	46.8	59.6	245	8	4190	342	8.37	76.97	16.45
	57.9	73.8	245	10	5110	417	8.32	76.97	13.29
	68.9	87.8	245	12	5980	488	8.25	76.97	11.17
	79.8	102.0	245	14	6800	555	8.17	76.97	9.65
273	45.9	58.5	273	7	5180	379	9.40	85.77	18.68
	52.5	66.6	273	8	5850	429	9.37	85.77	16.34
	64.9	82.6	273	10	7150	524	9.30	85.77	13.22
	77.2	98.4	273	12	8400	615	9.24	85.77	11.10
	89.4	114.0	273	14	9580	702	9.17	85.77	9.59
325	62.5	79.7	325	8	10010	616	11.20	102.10	16.34
	77.7	99.0	325	10	12290	756	11.10	102.10	13.14
	92.7	118.0	325	12	14470	891	11.10	102.10	11.01
	107.0	137.0	325	14	16570	1020	11.00	102.10	9.54
	122.0	155.0	325	16	18590	1140	10.90	102.10	8.37
368	71.0	90.5	368	8	14660	797	12.70	115.61	16.27
	88.3	112.0	368	10	18030	980	12.70	115.61	13.09
	105.0	134.0	368	12	21290	1160	12.60	115.61	11.01
	122.0	156.0	368	14	24430	1330	12.50	115.61	9.48
	139.0	177.0	368	16	27460	1490	12.50	115.61	8.32
	172.0	219.0	368	20	33210	1800	12.30	115.61	6.72
419	100.5	128.0	419	10	26880	1283	14.50	131.63	13.10
	120.1	153.0	419	12	31800	1518	14.40	131.63	10.96
	159.4	203.0	419	16	41190	1970	14.30	131.63	8.26
	197.0	251.0	419	20	50020	2390	14.10	131.63	6.68
529	115.0	147.0	529	9	49710	1879	18.40	166.19	14.45
	128.0	163.0	529	10	54920	2077	18.40	166.19	12.99

# HOLLOW SQUARE SECTION

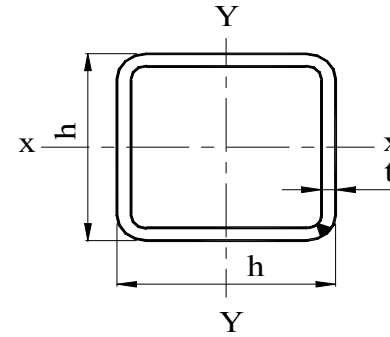

Dimensions		Weight	Area	Axis X-X & Y-Y			J	Surface Area	
h	t			I	S	r		U <sub>m</sub>	U <sub>t</sub>
mm	mm	kg/m	cm <sup>2</sup>	cm <sup>4</sup>	cm <sup>3</sup>	cm	cm <sup>4</sup>	x10 <sup>-2</sup> m <sup>2</sup> /m	m <sup>2</sup> /t
40	4.0	4.46	5.68	12.1	6.07	1.46	19.5	15.10	33.87
50	3.2	4.66	5.94	21.6	8.62	1.91	33.8	19.30	41.39
	4.0	5.71	7.28	25.5	10.2	1.87	40.4	19.10	33.42
	5.0	6.97	8.88	29.6	11.9	1.83	47.6	18.90	27.11
60	3.2	5.67	7.22	38.7	12.9	2.31	60.1	23.30	41.11
	4.0	6.97	8.88	46.1	15.4	2.28	72.4	23.10	33.14
	5.0	8.56	10.90	54.4	18.1	2.24	86.3	22.90	26.76
70	3.6	7.46	9.50	69.5	19.9	2.70	108	27.20	36.47
	5.0	10.13	12.90	90.1	25.7	2.64	142	26.90	26.56
80	3.6	8.56	10.90	106	26.5	3.11	164	31.20	36.46
	5.0	11.70	14.90	139	34.7	3.05	217	30.90	26.42
	6.3	14.44	18.40	165	41.3	3.00	261	30.60	21.19
90	3.6	9.73	12.40	154	34.1	3.52	237	35.20	36.16
	5.0	13.27	16.90	202	45.0	3.46	315	34.90	26.31
	6.3	16.41	20.90	242	53.9	3.41	381	34.60	21.09
100	4.0	12.01	15.30	234	46.8	3.91	361	39.10	32.55
	5.0	14.84	18.90	283	56.6	3.87	439	38.90	26.22
	6.3	18.37	23.40	341	68.2	3.81	533	38.60	21.01
	8.0	22.84	29.10	408	81.5	3.74	646	38.30	16.77
	10.0	27.87	35.50	474	94.9	3.65	761	37.90	13.60
120	5.0	17.98	22.90	503	83.8	4.69	775	46.90	26.09
	6.3	22.37	28.50	610	102	4.63	949	46.60	20.83
	8.0	27.87	35.50	738	123	4.56	1159	46.30	16.61
	10.0	34.15	43.50	870	145	4.47	1381	45.90	13.44
140	5.0	21.12	26.90	814	116	5.50	1251	54.90	26.00
	6.3	26.30	33.50	994	142	5.45	1538	54.60	20.76
	8.0	32.89	41.90	1212	173	5.38	1889	54.30	16.51
	10.0	40.43	51.50	1441	206	5.29	2269	53.90	13.33

# HOLLOW SQUARE SECTION

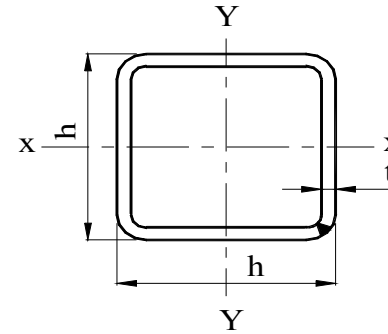

Dimensions		Weight	Area	Axis X-X & Y-Y			J	Surface Area	
h	t			I	S	r		U <sub>m</sub>	U <sub>t</sub>
mm	mm	kg/m	cm <sup>2</sup>	cm <sup>4</sup>	cm <sup>3</sup>	cm	cm <sup>4</sup>	x10 <sup>-2</sup> m <sup>2</sup> /m	m <sup>2</sup> /t
150	5.0	22.69	28.90	1009	135	5.91	1548	58.90	25.96
	6.3	28.26	36.00	1236	165	5.86	1907	58.60	20.74
	8.0	35.40	45.10	1510	201	5.78	2348	58.30	16.47
	10.0	43.57	55.50	1803	240	5.70	2829	57.90	13.29
	12.5	53.38	68.00	2125	283	5.59	3372	57.30	10.73
	16.0	66.33	84.50	2500	333	5.44	4029	56.60	8.53
180	6.3	34.23	43.60	2186	243	7.08	3357	70.60	20.63
	8.0	42.94	54.70	2689	299	7.01	4156	70.30	16.37
	10.0	52.99	67.50	3237	360	6.92	5041	69.90	13.19
	12.5	65.16	83.00	3856	428	6.82	6062	69.30	10.64
	16.0	81.64	104.00	4607	512	6.66	7339	68.60	8.40
200	6.3	38.15	48.60	3033	303	7.90	4647	78.60	20.60
	8.0	47.96	61.10	3744	374	7.83	5770	78.30	16.32
	10.0	59.27	75.50	4525	452	7.74	7020	77.90	13.14
	12.5	73.01	93.00	5419	542	7.63	8479	77.30	10.59
	16.0	91.85	117.00	6524	652	7.48	10330	76.60	8.34
250	6.3	48.04	61.20	6049	484	9.94	9228	98.60	20.52
	8.0	60.52	77.10	7510	601	9.87	11511	98.30	16.24
	10.0	74.97	95.50	9141	731	9.78	14086	97.90	13.06
	12.5	92.63	118.00	11050	884	9.68	17139	97.30	10.50
	16.0	116.97	149.00	13480	1078	9.53	21109	96.60	8.26
300	10.0	91.06	116.00	16150	1077	11.80	24776	118.00	12.96
	12.5	112.26	143.00	19630	1309	11.70	30290	117.00	10.42
	16.0	142.09	181.00	24160	1610	11.60	37566	117.00	8.23
350	10.0	106.76	136.00	26050	1489	13.90	39840	138.00	12.93
	12.5	131.88	168.00	31810	1817	13.80	48869	137.00	10.39
	16.0	167.21	213.00	39370	2250	13.60	60901	137.00	8.19
400	10.0	122.46	156.00	39350	1968	15.90	60028	158.00	12.90
	12.5	151.51	193.00	48190	2409	15.80	73815	157.00	10.36

# HOLLOW RECTANGULAR SECTION

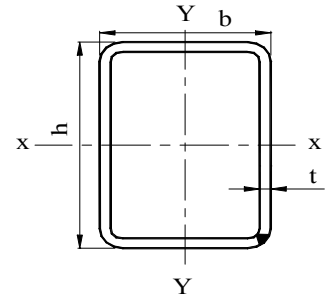

Dimensions			Weight	Area	Axis X-X			Axis Y-Y			J	Surface Area	
h	b	t			$I_x$	$S_x$	$r_x$	$I_y$	$S_y$	$r_y$		$U_m$	$U_t$
mm	mm	mm	kg/m <sup>1</sup>	cm <sup>2</sup>	cm <sup>4</sup>	cm <sup>3</sup>	cm	cm <sup>4</sup>	cm <sup>3</sup>	cm	cm <sup>4</sup>	x10 <sup>-2</sup> m <sup>2</sup> /m <sup>1</sup>	m <sup>2</sup> /t
50	30	2.6	3.03	3.86	12.4	4.96	1.79	5.5	3.6	1.19	12.1	15.40	50.80
		3.2	3.66	4.66	14.5	5.82	1.77	6.3	4.2	1.16	14.2	15.30	41.80
60	40	3.2	4.66	5.94	28.3	9.44	2.18	14.8	7.4	1.58	30.8	19.30	41.40
		4.0	5.71	7.28	33.6	11.2	2.15	17.3	8.7	1.54	36.6	19.10	33.40
80	40	3.2	5.67	7.22	58.1	14.5	2.84	19.1	9.6	1.63	46.1	23.30	41.10
		4.0	6.97	8.88	69.6	17.4	2.80	22.6	11.3	1.59	55.1	23.10	33.10
90	50	3.6	7.46	9.50	99.6	22.2	3.24	39.1	15.6	2.03	89.3	27.20	36.50
		5.0	10.13	12.90	130	28.9	3.18	50.0	20.0	1.97	116	26.90	26.60
100	50	3.2	7.17	9.14	117	23.5	3.58	39.1	15.6	2.07	93	29.30	40.80
		4.0	8.87	11.30	142	28.4	3.55	46.7	18.7	2.03	113	29.10	32.80
		5.0	10.91	13.90	170	34.0	3.50	55.1	22.0	1.99	135	28.90	26.50
		6.3	13.42	17.10	202	40.5	3.44	64.2	25.7	1.94	160	28.60	21.30
	60	3.6	8.56	10.90	147	29.3	3.66	65.4	21.8	2.45	142	31.20	36.30
		5.0	11.70	14.90	192	38.5	3.60	84.7	28.2	2.39	187	30.90	26.40
6.3	14.44	18.40	230	46.0	3.54	99.9	33.3	2.33	224	30.60	21.30		
	120	60	3.6	9.73	12.40	230	38.3	4.31	76.9	25.6	2.49	183	35.20
5.0			13.27	16.90	304	50.7	4.24	99.9	33.3	2.43	242	34.90	26.20
6.0			16.41	20.90	366	61.0	4.18	118	39.4	2.38	290	34.60	21.10
80		5.0	14.84	18.90	370	61.7	4.43	195	48.8	3.21	401	38.90	26.30
		6.3	18.37	23.40	447	74.6	4.37	234	58.4	3.16	486	38.60	21.00
		8.0	22.84	29.10	537	89.5	4.29	278	69.4	3.09	586	38.30	16.70
10.0	27.87	35.50	628	105	4.20	320	80.0	3.00	688	37.90	13.60		
150	100	5.0	18.76	23.90	747	99.5	5.59	396	79.1	4.07	806	48.90	26.10
		6.3	23.31	29.70	910	121	5.53	479	95.9	4.02	985	48.60	20.90
		8.0	29.12	37.10	1106	147	5.46	577	115	3.94	1202	48.30	16.60
		10.0	35.72	45.50	1312	175	5.37	678	136	3.86	1431	47.90	13.40
160	80	5.0	17.98	22.90	753	94.1	5.74	251	62.8	3.31	599	46.90	26.10
		6.3	22.30	28.50	917	115	5.68	302	75.6	3.26	729	46.60	20.90
		8.0	27.87	35.50	1113	139	5.60	361	90.2	3.19	882	46.30	16.60
		10.0	34.15	43.50	1318	165	5.50	419	105	3.10	1041	45.90	13.40
200	100	5.0	22.69	28.90	1509	151	7.23	509	102	4.20	1202	58.90	25.90
		6.3	28.26	36.00	1851	185	7.17	618	124	4.14	1473	58.60	20.70
		8.0	35.40	45.10	2269	227	7.09	747	149	4.07	1802	58.30	16.50
		10.0	43.57	55.50	2718	272	7.00	881	176	3.98	2154	57.90	13.30
		12.5	53.38	68.00	3218	322	6.88	1022	204	3.88	2541	57.30	10.70
		16.0	66.33	84.50	3808	381	6.71	1175	235	3.73	2988	56.60	8.52
250	150	6.3	38.15	48.60	4178	334	9.27	1886	252	6.23	4049	78.60	20.60
		8.0	47.96	61.10	5167	416	9.19	2317	309	6.16	5014	78.30	16.30
		10.0	59.27	75.50	6259	501	9.10	2784	371	6.07	6082	77.90	13.10
		12.5	73.01	93.00	7518	601	8.99	3310	441	5.97	7317	77.30	10.60
16.0	91.85	117.00	9089	727	8.83	3943	526	5.82	8863	76.60	8.37		
300	200	6.3	48.04	61.20	7880	525	11.30	4216	422	8.30	8468	98.60	20.50
		8.0	60.52	77.10	9898	653	11.30	5219	522	8.23	10550	98.30	16.20
		10.0	74.97	95.50	11940	796	11.20	6331	633	8.14	12890	97.90	13.10
		12.5	92.63	118.00	14460	964	11.10	7619	762	8.04	15650	97.30	10.50
16.0	116.97	149.00	17700	1180	10.90	9239	924	7.89	19220	96.60	8.26		
400	200	10.0	91.06	116.00	24140	1207	14.50	8138	814	8.39	19240	118.00	13.00
		12.5	112.26	143.00	29410	1471	14.30	9820	982	8.29	23410	117.00	10.40
		16.0	142.09	181.00	36300	1815	14.20	11950	1195	8.14	28840	117.00	8.24
450	250	10.0	106.76	136.00	37180	1653	16.60	14900	1192	10.50	33250	138.00	13.00
		12.5	131.88	168.00	45470	2021	16.50	18100	1448	10.40	40670	137.00	10.40
		16.0	167.21	213.00	56420	2508	16.30	22250	1780	10.20	50480	137.00	8.20

# MASS (kg/m<sup>3</sup>) FOR RECTANGULAR STEEL PLATES\*

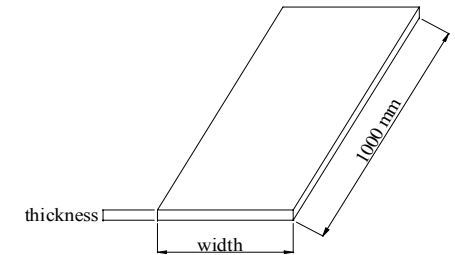

Width (mm)	Thickness (mm)															
	5	6	7	8	10	12	14	16	18	20	22	25	28	30	35	40
25	0.98	1.18	1.53	1.57	1.96	2.36	2.75	3.14	3.53	3.93	4.32	4.91	5.50	5.89	6.87	7.85
28	1.10	1.32	1.72	1.76	2.20	2.64	3.08	3.52	3.96	4.40	4.84	5.50	6.15	6.59	7.69	8.79
30	1.18	1.41	1.84	1.88	2.36	2.83	3.30	3.77	4.24	4.71	5.18	5.89	6.59	7.07	8.24	9.42
35	1.37	1.65	2.14	2.20	2.75	3.30	3.85	4.40	4.95	5.50	6.04	6.87	7.69	8.24	9.62	10.99
40	1.57	1.88	2.45	2.51	3.14	3.77	4.40	5.02	5.65	6.28	6.91	7.85	8.79	9.42	10.99	12.56
45	1.77	2.12	2.76	2.83	3.53	4.24	4.95	5.65	6.36	7.07	7.77	8.83	9.89	10.60	12.36	14.13
50	1.96	2.36	3.06	3.14	3.93	4.71	5.50	6.28	7.07	7.85	8.64	9.81	10.99	11.78	13.74	15.70
55	2.16	2.59	3.37	3.45	4.32	5.18	6.04	6.91	7.77	8.64	9.50	10.79	12.09	12.95	15.11	17.27
60	2.36	2.83	3.68	3.77	4.71	5.65	6.59	7.54	8.48	9.42	10.36	11.78	13.19	14.13	16.49	18.84
70	2.75	3.30	4.29	4.40	5.50	6.59	7.69	8.79	9.89	10.99	12.09	13.74	15.39	16.49	19.23	21.98
80	3.14	3.77	4.90	5.02	6.28	7.54	8.79	10.05	11.30	12.56	13.82	15.70	17.58	18.84	21.98	25.12
90	3.53	4.24	5.51	5.65	7.07	8.48	9.89	11.30	12.72	14.13	15.54	17.66	19.78	21.20	24.73	28.26
100	3.93	4.71	6.13	6.28	7.85	9.42	10.99	12.56	14.13	15.70	17.27	19.63	21.98	23.55	27.48	31.40
110	4.32	5.18	6.74	6.91	8.64	10.36	12.09	13.82	15.54	17.27	19.00	21.59	24.18	25.91	30.22	34.54
120	4.71	5.65	7.35	7.54	9.42	11.30	13.19	15.07	16.96	18.84	20.72	23.55	26.38	28.26	32.97	37.68
140	5.50	6.59	8.58	8.79	10.99	13.19	15.39	17.58	19.78	21.98	24.18	27.48	30.77	32.97	38.47	43.96
160	6.28	7.54	9.80	10.05	12.56	15.07	17.58	20.10	22.61	25.12	27.63	31.40	35.17	37.68	43.96	50.24
180	7.07	8.48	11.03	11.30	14.13	16.96	19.78	22.61	25.43	28.26	31.09	35.33	39.56	42.39	49.46	56.52
200	7.85	9.42	12.25	12.56	15.70	18.84	21.98	25.12	28.26	31.40	34.54	39.25	43.96	47.10	54.95	62.80
220	8.64	10.36	13.48	13.82	17.27	20.72	24.18	27.63	31.09	34.54	37.99	43.18	48.36	51.81	60.45	69.08
250	9.81	11.78	15.31	15.70	19.63	23.55	27.48	31.40	35.33	39.25	43.18	49.06	54.95	58.88	68.69	78.50
300	11.78	14.13	18.38	18.84	23.55	28.26	32.97	37.68	42.39	47.10	51.81	58.88	65.94	70.65	82.43	94.20
350	13.74	16.49	21.44	21.98	27.48	32.97	38.47	43.96	49.46	54.95	60.45	68.69	76.93	82.43	96.16	109.90
400	15.70	18.84	24.50	25.12	31.40	37.68	43.96	50.24	56.52	62.80	69.08	78.50	87.92	94.20	109.90	125.60
450	17.66	21.20	27.56	28.26	35.33	42.39	49.46	56.52	63.59	70.65	77.72	88.31	98.91	105.98	123.64	141.30
500	19.63	23.55	30.63	31.40	39.25	47.10	54.95	62.80	70.65	78.50	86.35	98.13	109.90	117.75	137.38	157.00
600	23.55	28.26	36.75	37.68	47.10	56.52	65.94	75.36	84.78	94.20	103.62	117.75	131.88	141.30	164.85	188.40
700	27.48	32.97	42.88	43.96	54.95	65.94	76.93	87.92	98.91	109.90	120.89	137.38	153.86	164.85	192.33	219.80
800	31.40	37.68	49.00	50.24	62.80	75.36	87.92	100.48	113.04	125.60	138.16	157.00	175.84	188.40	219.80	251.20
900	35.33	42.39	55.13	56.52	70.65	84.78	98.91	113.04	127.17	141.30	155.43	176.63	197.82	211.95	247.28	282.60
1000	39.25	47.10	61.25	62.80	78.50	94.20	109.90	125.60	141.30	157.00	172.70	196.25	219.80	235.50	274.75	314.00

\*Steel density 7850 kg/m<sup>3</sup>

# RAILS

## Dimensions

Rail Type	h	h <sub>1</sub>	h <sub>2</sub>	2c <sub>k</sub>	2c <sub>f</sub>	d	t <sub>0</sub>	t <sub>2</sub>	a <sub>f</sub>	r <sub>1</sub>	r <sub>3</sub>	r <sub>4</sub>	r <sub>5</sub>	r <sub>6</sub>	a <sub>r</sub>
	mm	mm	mm	mm	mm	mm	mm	mm	mm	mm	mm	mm	mm	mm	mm
vst	130	43	33	60	100	12	23	12	67	13	10	80		200	36
I	145	45	37	65	125	14	25			13	6	30	80	300	19
III	159	49	36	70	140	16	30	13	93	13	16	508	80	300	19
IV	161	51	39	67	125	16	30	14	91	13	16	508	80	300	19
VI	172	51	38	72	150	16.5	32	13	100	13	35	120	80	300	21

## Properties

Rail Type	Weight	Area	I <sub>x</sub>	S <sub>xt</sub>	S <sub>xb</sub>	e <sub>x</sub>	I <sub>y</sub>	S <sub>y</sub>
	kg/m <sup>1</sup>	cm <sup>2</sup>	cm <sup>4</sup>	cm <sup>3</sup>	cm <sup>3</sup>	cm	cm <sup>4</sup>	cm <sup>3</sup>
vst	35.7	45.5	1000	156	153	6.6	157	31
I	46.2	58.8	1630	216	235	6.9	298	47.7
III	54.4	69.3	2350	279	313	7.5	418	59.6
IV	53.8	68.8	2310	276	298	7.8	341	54.6
VI	60.3	76.9	3060	336	377	8.1	513	68.4

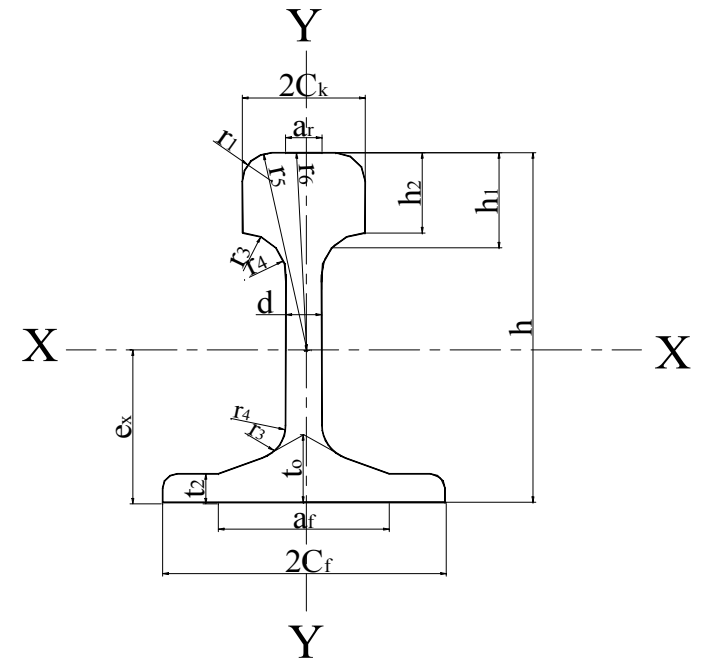



# RAILS

## Dimensions

Rail Type	h	2c <sub>f</sub>	a <sub>f</sub>	2c <sub>k</sub>	d	t <sub>1</sub>	t <sub>2</sub>	t <sub>3</sub>	h <sub>1</sub>	h <sub>2</sub>	r <sub>1</sub>	r <sub>2</sub>	r <sub>3</sub>	r <sub>4</sub>	r <sub>5</sub>
	mm	mm	mm	mm	mm	mm	mm	mm	mm	mm	mm	mm	mm	mm	mm
A 45	55	125	54	45	24	14.5	11	8	24	20	4	3	4	5	4
A 55	65	150	66	55	31	17.5	12.5	9	28.5	25	5	5	5	6	5
A 65	75	175	78	65	38	20	14	10	34	30	6	5	5	6	5
A 75	85	200	90	75	45	22	15.4	11	39.5	35	8	6	6	8	6
A 100	95	200	100	100	60	23	16.5	12	45.5	40	10	6	6	8	6
A 120	105	220	120	120	72	30	20	14	55.5	47.5	10	6	10	10	6

## Properties

Rail Type	Weight	Area	I <sub>x</sub>	S <sub>xt</sub>	S <sub>xb</sub>	e <sub>x</sub>	I <sub>y</sub>	S <sub>y</sub>
	kg/m	cm <sup>2</sup>	cm <sup>4</sup>	cm <sup>3</sup>	cm <sup>3</sup>	cm	cm <sup>4</sup>	cm <sup>3</sup>
A 45	22.2	28.3	91	27.5	41.6	2.2	169	27.0
A 55	32.0	40.7	182	46.9	69.5	2.6	337	44.9
A 65	43.5	55.4	327	73.7	106.9	3.1	609	69.6
A 75	56.6	72.1	545	109.0	155.7	3.5	1010	101.0
A 100	75.2	95.6	888	170.0	207.0	4.3	1360	136.0
A 120	101.3	129.0	1420	249.0	295.8	4.8	2370	215.0

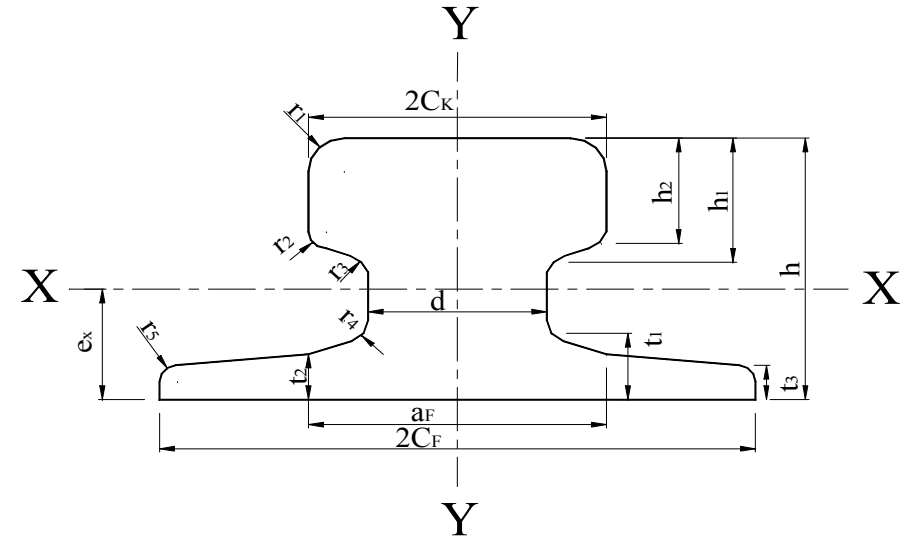

# RAILS

## Dimensions

Rail Type	Depth	Head		base		Web		k	h	r	R	R <sub>1</sub>	R <sub>2</sub>	Alpha
	d	c	c <sub>1</sub>	b	t	w	g							
	mm	mm	mm	mm	mm	mm	mm							
USS or BETH 135	146	87	76	132	12	32	63	27	71	356	305	19	19	13
BETH 171	152	109	102	152	16	32	67	32	70	FLAT	VERT	19	22	12
USS or BETH 175	152	108	102	152	13	38	68	29	79	457	VERT	29	51	12

## Properties

Rail Type	Weight	Area	I <sub>x</sub>	S <sub>xt</sub>	S <sub>xb</sub>	e <sub>x</sub>
	kg/m <sup>1</sup>	cm <sup>2</sup>	cm <sup>4</sup>	cm <sup>3</sup>	cm <sup>3</sup>	cm
USS & BETH 135	67	85.9	2110	282	295	7.11
BETH 171	84.9	108	3060	402	400	7.65
USS & BETH 175	86.8	110	2920	386	381	7.67

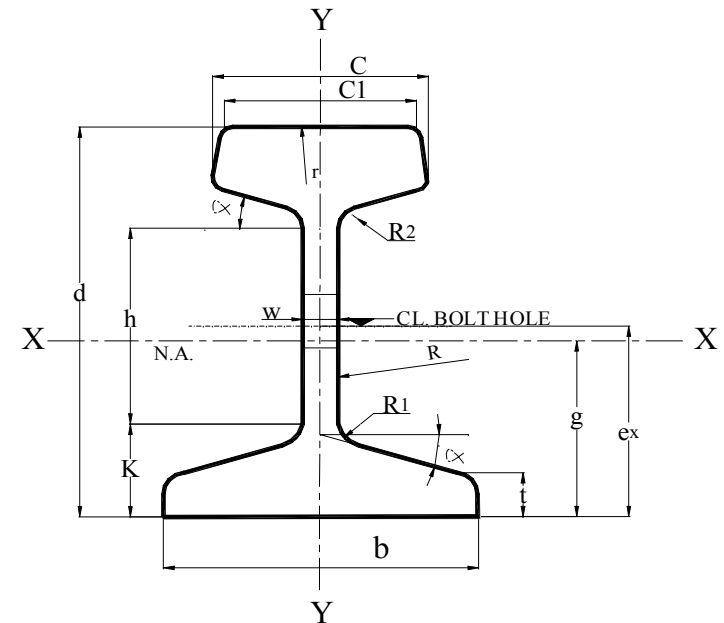

# RAILS

## Dimensions

Rail Type	Depth	Head	Base		Web		k	h	r	r <sub>c</sub>	R
	d	c	b	t	w	g					
	mm	mm	mm	mm	mm	mm					
ASCE 40	89	48	89	6	10	40	16	47	305	6.4	305
ASCE 60	108	60	108	7	12	52	19	58	305	6.4	305
ASCE 85	132	65	132	8	14	63	23	70	305	6.4	305
BETH 104	127	64	127	13	25	62	27	62	305	12.7	89
USS 105	132	65	132	10	24	56	25	61	305	6.4	305

## Properties

Rail Type	Weight	Area	I <sub>x</sub>	S <sub>xt</sub>	S <sub>xb</sub>	e <sub>x</sub>
	kg/m	cm <sup>2</sup>	cm <sup>4</sup>	cm <sup>3</sup>	cm <sup>3</sup>	cm
ASCE 40	19.8	25.4	272	58.8	63.7	4.27
60	29.8	38.3	606	108	116	5.21
85	42.2	53.7	1250	182	199	6.27
BETH 104	51.6	66.4	1240	175	221	5.61
USS 105	52.1	66.5	1430	203	234	6.12

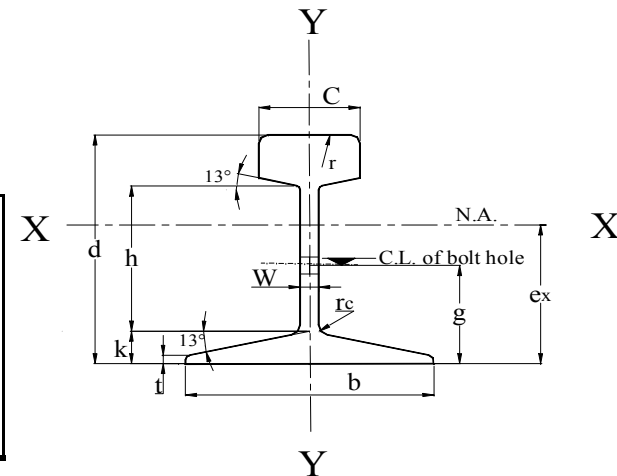

# COMBINED HOT ROLLED SECTIONS

TWO EQUAL ANGLES BACK TO BACK

TWO UNEQUAL ANGLES SHORT LEGS BACK TO BACK

TWO UNEQUAL ANGLES LONG LEGS BACK TO BACK

TWO CHANNELS (U.P.N.) BACK TO BACK

TWO CHANNELS (U.P.N.) TOE TO TOE

SYMMETRICAL WELDED I-BEAMS

UNSYMMETRICAL WELDED I-BEAMS

I.P.E +CHANNEL (U.P.N.)

## TWO EQUAL ANGLES Back to Back

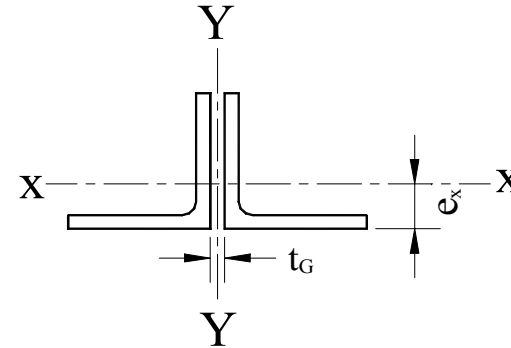

size		Weight	Area	Axis X-X				$r_y$ (cm) About Axis Y-Y			
a	s			$I_x$	$S_x$	$r_x$	$e_x$	$t_G$ (mm)			
mm	mm	kg/m <sup>1</sup>	cm <sup>2</sup>	cm <sup>4</sup>	cm <sup>3</sup>	cm	cm	8	10	12	14
30	3	2.72	3.48	2.82	1.30	0.90	0.84	1.53	1.61	1.70	1.78
	4	3.56	4.54	3.62	1.72	0.89	0.89	1.57	1.65	1.74	1.82
	5	4.36	5.56	4.32	2.08	0.88	0.92	1.59	1.67	1.76	1.84
35	3	3.20	4.08	4.58	1.80	1.06	0.96	1.72	1.80	1.89	1.97
	4	4.20	5.34	5.92	2.36	1.05	1.00	1.75	1.83	1.91	2.00
	5	5.14	6.56	7.12	2.90	1.04	1.04	1.78	1.86	1.94	2.03
40	4	4.84	6.16	8.96	3.12	1.21	1.12	1.94	2.02	2.10	2.19
	5	5.94	7.58	10.86	3.82	1.20	1.16	1.97	2.05	2.13	2.21
	6	7.04	8.96	12.66	4.52	1.19	1.20	1.99	2.08	2.16	2.24
45	5	6.76	8.60	15.66	4.86	1.35	1.28	2.16	2.23	2.31	2.40
	6	8.00	10.18	18.32	5.76	1.34	1.32	2.18	2.26	2.34	2.42
	7	9.20	11.72	20.80	6.62	1.33	1.36	2.21	2.29	2.37	2.45
50	5	7.54	9.60	22.00	6.10	1.51	1.40	2.35	2.43	2.51	2.59
	6	8.94	11.38	25.60	7.02	1.50	1.45	2.38	2.46	2.54	2.62
	7	10.30	13.12	29.20	8.30	1.49	1.49	2.41	2.49	2.57	2.65
55	5	8.36	10.64	29.40	7.40	1.66	1.52	2.54	2.61	2.69	2.77
	6	9.90	12.62	35.60	8.80	1.66	1.56	2.57	2.65	2.72	2.80
	8	12.92	16.46	44.20	11.44	1.64	1.64	2.62	2.70	2.78	2.86
60	6	10.84	13.82	45.60	10.58	1.82	1.69	2.77	2.85	2.93	3.00
	8	14.18	18.06	58.20	13.76	1.80	1.77	2.82	2.90	2.98	3.06
	10	17.38	22.20	69.80	16.82	1.78	1.85	2.87	2.95	3.03	3.11

# TWO EQUAL ANGLES Back to Back

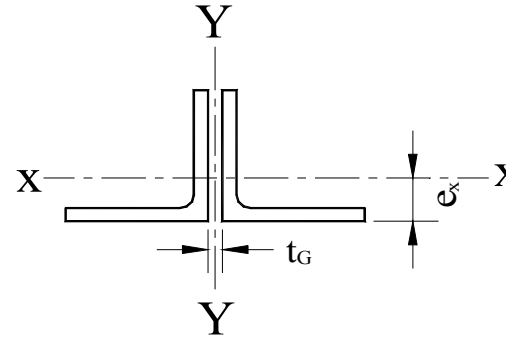

size		Weight	Area	Axis X-X				r <sub>y</sub> (cm) About Axis Y-Y			
a	s			I <sub>x</sub>	S <sub>x</sub>	r <sub>x</sub>	e <sub>x</sub>	t <sub>G</sub> (mm)			
mm	mm	kg/m <sup>1</sup>	cm <sup>2</sup>	cm <sup>4</sup>	cm <sup>3</sup>	cm	cm	8	10	12	14
65	7	13.64	17.40	66.8	14.3	1.96	1.85	2.98	3.06	3.14	3.22
	8	15.46	19.70	75.0	16.3	1.95	1.89	3.01	3.08	3.16	3.24
	9	17.24	22.00	82.6	18.1	1.94	1.93	3.03	3.11	3.19	3.27
70	7	14.76	18.80	84.8	16.9	2.12	1.97	3.18	3.26	3.33	3.41
	9	18.68	23.80	105.2	21.2	2.10	2.05	3.23	3.30	3.38	3.46
	11	22.40	28.60	123.6	25.4	2.09	2.13	3.28	3.36	3.44	3.52
75	7	15.88	20.20	104.8	17.3	2.28	2.03	3.33	3.41	3.48	3.56
	8	18.06	23.00	117.8	22.0	2.26	2.13	3.39	3.47	3.54	3.62
	10	22.20	28.20	142.8	27.0	2.25	2.21	3.45	3.52	3.60	3.68
80	8	19.32	24.60	144.6	25.2	2.42	2.26	3.60	3.67	3.75	3.82
	10	23.80	30.20	175.0	31.0	2.41	2.34	3.65	3.72	3.80	3.88
	12	28.20	35.80	204.0	36.4	2.39	2.41	3.69	3.77	3.84	3.92
90	9	24.40	31.00	232.0	36.0	2.74	2.54	4.02	4.09	4.17	4.24
	11	29.70	37.40	276.0	43.2	2.72	2.62	4.06	4.14	4.22	4.29
	13	34.20	43.60	316.0	50.2	2.69	2.70	4.10	4.18	4.26	4.34
100	10	30.20	38.40	354.0	49.4	3.04	2.82	4.43	4.50	4.58	4.65
	12	35.60	45.40	414.0	58.4	3.02	2.90	4.47	4.55	4.62	4.70
	14	41.20	52.40	470.0	67.0	3.00	2.98	4.52	4.59	4.67	4.75
110	10	33.20	42.40	478.0	60.2	3.36	3.07	4.83	4.90	4.98	5.05
	12	39.40	50.20	560.0	71.4	3.34	3.15	4.87	4.95	5.02	5.10
	14	45.60	58.00	638.0	82.0	3.32	3.21	4.90	4.98	5.05	5.13
120	12	43.20	55.00	736.0	85.4	3.65	3.40	5.27	5.34	5.42	5.49
	13	46.60	59.80	788.0	92.0	3.64	3.44	5.29	5.36	5.44	5.51
	15	53.20	67.80	892.0	105.0	3.63	3.51	5.34	5.41	5.48	5.56

## TWO ANGLES EQUAL Back to Back

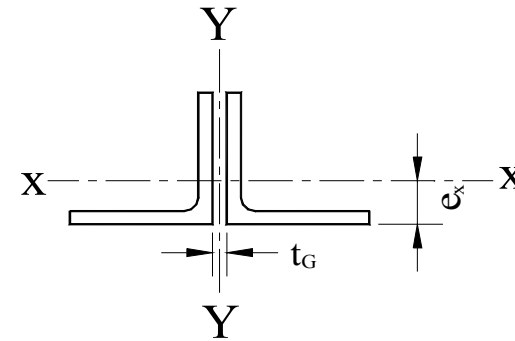

size		Weight	Area	Axis X-X				$r_y$ (cm) About Axis Y-Y			
a	s			$I_x$	$S_x$	$r_x$	$e_x$	$t_G$ (mm)			
mm	mm	$\text{kg/m}^1$	$\text{cm}^2$	$\text{cm}^4$	$\text{cm}^3$	cm	cm	8	10	12	14
130	12	47.20	60.00	944	100.8	3.97	3.64	5.66	5.74	5.81	5.88
	14	54.40	69.40	1080	110.4	3.94	3.72	5.70	5.77	5.85	5.92
	16	61.80	78.60	1210	131.6	3.92	3.80	5.75	5.82	5.89	5.97
140	13	55.00	70.00	1276	126.6	4.27	3.92	6.07	6.15	6.22	6.29
	15	62.80	80.00	1446	144.6	4.25	4.00	6.12	6.19	6.26	6.34
150	14	63.20	80.60	1690	156.4	4.58	4.21	6.50	6.57	6.64	6.71
	15	67.80	86.00	1796	165.0	4.57	4.25	6.52	6.59	6.66	6.74
	16	71.80	91.40	1898	177.4	4.56	4.29	6.54	6.61	6.69	6.76
	18	80.20	102.00	2100	198.6	4.54	4.36	6.58	6.65	6.72	6.80
	20	88.40	112.60	2300	218.0	4.51	4.44	6.62	6.69	6.76	6.84
160	15	72.40	92.20	2200	191.2	4.88	4.49	6.91	6.98	7.05	7.12
	17	81.40	103.60	2460	216.0	4.86	4.57	6.95	7.02	7.10	7.17
	19	90.20	115.00	2700	236.0	4.84	4.65	6.99	7.07	7.14	7.21
180	16	87.00	110.80	3360	260.0	5.51	5.02	7.73	7.80	7.87	7.94
	18	97.20	123.80	3740	290.0	5.49	5.10	7.77	7.84	7.91	7.99
	20	107.40	136.80	4080	320.0	5.47	5.18	7.81	7.89	7.96	8.03
	22	117.20	149.40	4220	348.0	5.44	5.26	7.85	7.92	8.00	8.07
200	16	97.00	123.60	4680	336.0	6.15	5.52	8.54	8.61	8.68	8.75
	18	108.60	138.20	5200	362.0	6.13	5.60	8.58	8.65	8.72	8.79
	20	119.80	152.80	5700	398.0	6.11	5.68	8.62	8.69	8.76	8.83
	24	142.20	181.20	6660	470.0	6.06	5.84	8.70	8.77	8.84	8.92
	28	164.00	210.00	7560	540.0	6.02	5.99	8.78	8.85	8.93	9.00

## TWO UNEQUAL ANGLES Short Legs Back to Back

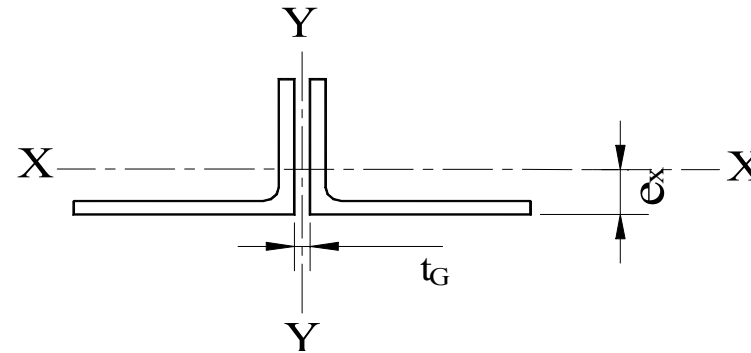

Size			Weight	Area	Axis X-X				r <sub>y</sub> (cm) About Axis Y-Y			
a	b	s			I <sub>x</sub>	S <sub>x</sub>	r <sub>x</sub>	e <sub>x</sub>	t <sub>G</sub> (mm)			
mm	mm	mm	kg/m <sup>1</sup>	cm <sup>2</sup>	cm <sup>4</sup>	cm <sup>3</sup>	cm	cm	8	10	12	14
30	20	3	2.22	2.84	0.88	0.58	0.56	0.50	1.68	1.76	1.85	1.93
		4	2.90	3.70	1.10	0.76	0.55	0.54	1.71	1.79	1.88	1.96
40	20	3	2.70	3.44	0.94	0.60	0.52	0.44	2.23	2.31	2.39	2.48
		4	3.54	4.50	1.20	0.78	0.52	0.48	2.25	2.34	2.42	2.51
45	30	3	3.44	4.38	3.20	1.40	0.86	0.70	2.32	2.40	2.48	2.57
		4	4.50	5.74	4.10	1.82	0.85	0.74	2.36	2.44	2.52	2.60
		5	5.54	7.06	4.94	2.22	0.84	0.78	2.38	2.46	2.55	2.63
60	30	5	6.74	8.58	5.20	2.24	0.78	0.68	3.18	3.26	3.34	3.43
		7	9.18	11.70	6.82	3.04	0.76	0.76	3.24	3.32	3.41	3.49
60	40	5	7.52	9.58	12.22	4.04	1.13	0.97	3.02	3.10	3.18	3.26
		6	8.92	11.36	14.24	4.76	1.12	1.01	3.05	3.13	3.21	3.29
		7	10.28	13.10	16.14	5.48	1.11	1.05	3.07	3.15	3.24	3.32
75	50	5	9.48	12.08	24.60	6.42	1.43	1.17	3.68	3.76	3.84	3.91
		7	13.02	16.60	33.00	8.78	1.41	1.25	3.72	3.80	3.88	3.96
		9	16.46	21.00	40.40	10.98	1.39	1.32	3.77	3.85	3.93	4.01
80	40	6	10.82	13.78	15.18	4.88	1.05	0.88	4.13	4.21	4.29	4.37
		8	14.14	18.02	19.36	6.36	1.04	0.95	4.19	4.27	4.35	4.43
90	60	6	13.64	17.38	51.60	11.22	1.72	1.41	4.37	4.44	4.52	4.60
		8	17.92	22.80	66.00	14.62	1.70	1.49	4.41	4.49	4.57	4.65
100	50	6	13.70	17.46	30.60	7.72	1.32	1.04	5.04	5.11	5.19	5.27
		8	17.98	23.00	39.00	10.08	1.31	1.13	5.10	5.18	5.26	5.34
		10	22.20	28.20	46.80	12.34	1.29	1.20	5.15	5.23	5.31	5.39
100	65	7	17.54	22.40	75.20	15.08	1.84	1.51	4.82	4.90	4.97	5.05
		9	22.20	28.40	93.40	19.04	1.82	1.59	4.87	4.95	5.03	5.11
		11	26.80	34.20	110.20	22.80	1.80	1.67	4.92	5.00	5.08	5.16



## TWO UNEQUAL ANGLES Short Legs Back to Back

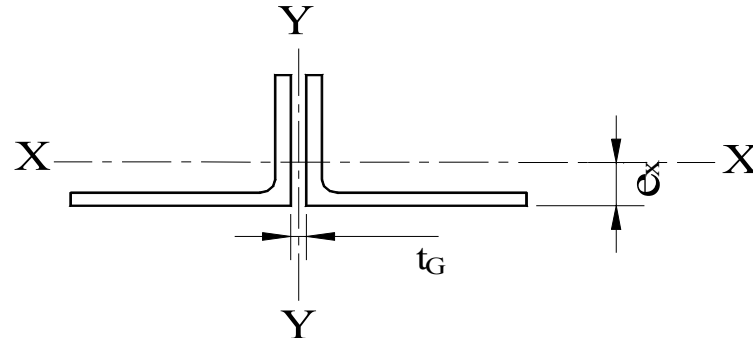

Size			Weight	Area	Axis X-X				$r_y$ (cm) About Axis Y-Y			
a	b	s			$I_x$	$S_x$	$r_x$	$e_x$	$t_G$ (mm)			
mm	mm	mm	$\text{kg/m}^1$	$\text{cm}^2$	$\text{cm}^4$	$\text{cm}^3$	cm	cm	8	10	12	14
120	80	8	24.40	31.00	161.6	26.40	2.29	1.87	5.70	5.77	5.85	5.93
		10	30.00	38.20	196.2	32.40	2.27	1.95	5.75	5.83	5.91	5.98
		12	35.60	45.40	228.0	38.20	2.25	2.03	5.79	5.87	5.95	6.03
		14	41.00	52.40	260.0	44.00	2.23	2.10	5.84	5.92	6.00	6.08
130	65	8	23.80	30.20	89.6	17.44	1.72	1.37	6.48	6.56	6.63	6.71
		10	29.20	37.20	108.4	21.40	1.71	1.45	6.54	6.61	6.69	6.77
		12	34.60	44.20	126.0	25.40	1.69	1.53	6.59	6.67	6.74	6.82
130	90	10	33.20	42.40	282.0	41.20	2.58	2.18	6.13	6.21	6.28	6.36
		12	39.40	50.20	330.0	48.80	2.56	2.26	6.65	6.73	6.81	6.89
150	75	9	30.60	39.00	156.6	26.40	2.00	1.57	7.46	7.53	7.61	7.69
		11	37.20	47.20	186.0	31.80	1.98	1.65	7.51	7.58	7.66	7.74
150	100	10	38.00	48.40	396.0	51.60	2.86	2.34	7.06	7.14	7.21	7.29
		12	45.20	57.40	464.0	61.20	2.84	2.42	7.12	7.19	7.27	7.34
		14	52.20	66.40	528.0	70.40	2.82	2.50	7.16	7.23	7.31	7.38
160	80	10	36.40	46.40	208.0	33.00	2.12	1.69	7.92	8.00	8.08	8.15
		12	43.20	55.00	244.0	39.20	2.10	1.77	7.97	8.05	8.13	8.21
		14	50.00	63.60	278.0	45.00	2.09	1.85	8.03	8.11	8.19	8.26
180	90	10	41.20	52.40	302.0	42.20	2.40	1.85	8.85	8.92	9.00	9.08
		12	49.00	62.40	354.0	50.20	2.38	1.93	8.90	8.97	9.05	9.13
		14	56.60	72.20	404.0	57.80	2.37	2.01	8.95	9.03	9.11	9.18
200	100	10	46.00	58.40	420.0	52.60	2.68	2.01	9.77	9.85	9.92	10.00
		12	54.60	69.60	494.0	62.60	2.67	2.10	9.83	9.90	9.98	10.05
		14	63.20	80.60	564.0	72.20	2.65	2.18	9.88	9.96	10.03	10.11
		16	71.80	91.40	632.0	81.60	2.63	2.26	9.92	10.00	10.08	10.15

# TWO UNEQUAL ANGLES Long Legs Back to Back

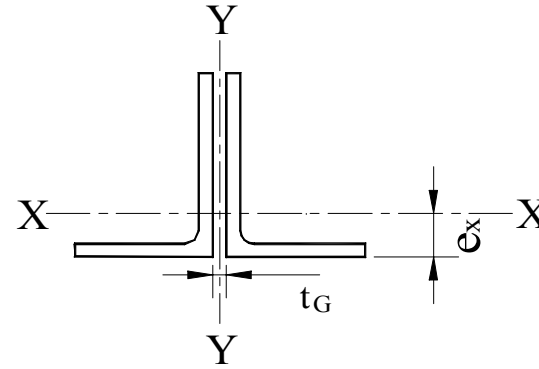

Size			Weight	Area	Axis X-X				r <sub>y</sub> (cm) About Axis Y-Y			
a	b	s			I <sub>x</sub>	S <sub>x</sub>	r <sub>x</sub>	e <sub>x</sub>	t <sub>G</sub> (mm)			
mm	mm	mm	kg/m	cm <sup>2</sup>	cm <sup>4</sup>	cm <sup>3</sup>	cm	cm	8	10	12	14
30	20	3	2.22	2.84	2.50	1.24	0.94	0.99	1.06	1.15	1.23	1.32
		4	2.90	3.70	3.18	1.62	0.93	1.03	1.09	1.18	1.27	1.36
40	20	3	2.70	3.44	5.58	2.16	1.27	1.43	0.99	1.07	1.16	1.25
		4	3.54	4.50	7.18	2.84	1.26	1.47	1.02	1.11	1.20	1.29
45	30	3	3.44	4.38	8.94	2.92	1.43	1.43	1.40	1.48	1.56	1.64
		4	4.50	5.74	11.56	3.82	1.42	1.48	1.42	1.50	1.59	1.67
		5	5.54	7.06	13.98	5.90	1.41	1.52	1.45	1.53	1.62	1.70
60	30	5	6.74	8.58	31.20	8.08	1.90	2.15	1.33	1.41	1.50	1.59
		7	9.18	11.70	41.40	11.00	1.88	2.24	1.39	1.47	1.56	1.65
60	40	5	7.52	9.58	34.40	8.50	1.89	1.96	1.78	1.85	1.93	2.02
		6	8.92	11.36	40.20	10.06	1.88	2.00	1.80	1.88	1.96	2.04
		7	10.28	13.10	46.00	11.58	1.87	2.04	1.83	1.91	1.99	2.07
75	50	5	9.48	12.08	68.80	13.48	2.39	2.40	2.12	2.20	2.28	2.35
		7	13.02	16.60	92.80	18.48	2.36	2.48	2.17	2.25	2.33	2.41
		9	16.46	21.00	114.8	23.20	2.34	2.56	2.21	2.29	2.37	2.45
80	40	6	10.82	13.78	89.80	17.46	2.55	2.85	1.66	1.73	1.81	1.90
		8	14.14	18.02	115.2	22.80	2.53	2.94	1.70	1.78	1.87	1.95
90	60	6	13.64	17.38	143.4	23.40	2.87	2.89	2.50	2.57	2.65	2.72
		8	17.92	22.80	185.0	30.80	2.85	2.97	2.54	2.62	2.69	2.77
100	50	6	13.70	17.46	179.4	27.60	3.20	3.49	1.95	2.03	2.11	2.18
		8	17.98	23.00	232.0	36.00	3.18	3.59	2.01	2.09	2.17	2.25
		10	22.20	28.20	282.0	44.40	3.16	3.67	2.06	2.13	2.21	2.30
100	65	7	17.54	22.40	226.0	33.20	3.17	3.23	2.65	2.73	2.80	2.88
		9	22.20	28.40	282.0	42.00	3.15	3.32	2.70	2.77	2.85	2.93
		11	26.80	34.20	334.0	50.60	3.13	3.40	2.74	2.82	2.90	2.98

## TWO UNEQUAL ANGLES Long Legs Back to Back

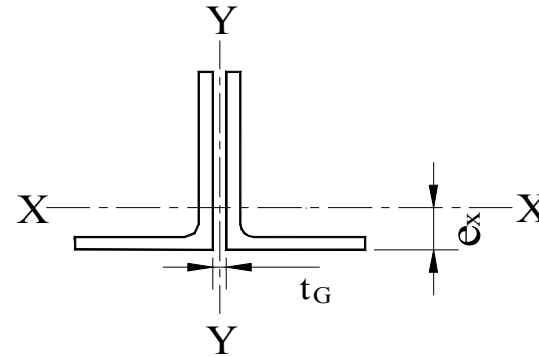

Size			Weight	Area	Axis X-X				$r_y$ (cm) About Axis Y-Y			
a	b	s			$I_x$	$S_x$	$r_x$	$e_x$	$t_G$ (mm)			
mm	mm	mm	$kg/m^1$	$cm^2$	$cm^4$	$cm^3$	cm	cm	8	10	12	14
120	80	8	24.40	31.00	452	55.20	3.82	3.83	3.22	3.30	3.37	3.44
		10	30.00	38.20	552	68.20	3.80	3.92	3.27	3.34	3.41	3.49
		12	35.60	45.40	646	80.80	3.77	4.00	3.31	3.39	3.46	3.54
		14	41.00	52.40	736	92.80	3.75	4.08	3.35	3.43	3.50	3.58
130	65	8	23.80	30.20	526	62.20	4.17	4.56	2.47	2.54	2.62	2.69
		10	29.20	37.20	642	76.80	4.15	4.65	2.52	2.59	2.67	2.75
		12	34.60	44.20	752	91.00	4.12	4.74	2.57	2.64	2.72	2.80
130	90	10	33.20	42.40	716	81.00	4.11	4.15	3.65	3.72	3.79	3.87
		12	39.40	50.20	840	96.00	4.09	4.84	3.69	3.76	3.84	3.91
150	75	9	30.60	39.00	910	93.60	4.83	5.28	2.81	2.88	2.95	3.03
		11	37.20	47.20	1090	113.2	4.80	5.37	2.85	2.92	3.00	3.07
150	100	10	38.00	48.40	1104	108.2	4.78	4.80	3.96	4.03	4.10	4.17
		12	45.20	57.40	1300	128.4	4.76	4.89	4.00	4.07	4.15	4.22
		14	52.20	66.40	1488	148.2	4.73	4.97	4.05	4.12	4.19	4.27
160	80	10	36.40	46.40	1222	117.8	5.14	5.63	2.98	3.05	3.12	3.19
		12	43.20	55.00	1440	140.0	5.11	5.72	3.02	3.09	3.17	3.24
		14	50.00	63.60	1646	161.4	5.09	5.81	3.07	3.14	3.22	3.30
180	90	10	41.20	52.40	1760	150.2	5.80	6.28	3.29	3.36	3.43	3.50
		12	49.00	62.40	2080	178.6	5.77	6.37	3.33	3.40	3.47	3.55
		14	56.60	72.20	2380	206.0	5.75	6.46	3.38	3.45	3.53	3.60
200	100	10	46.00	58.40	2440	184.4	6.46	6.93	3.60	3.67	3.74	3.81
		12	54.60	69.60	2880	222.0	6.43	7.03	3.66	3.73	3.80	3.87
		14	63.20	80.60	3300	256.0	6.41	7.12	3.70	3.77	3.84	3.91
		16	71.80	91.40	3720	290.0	6.38	7.20	3.74	3.81	3.89	3.96

# TWO CHANNELS (U.P.N.) BACK to BACK

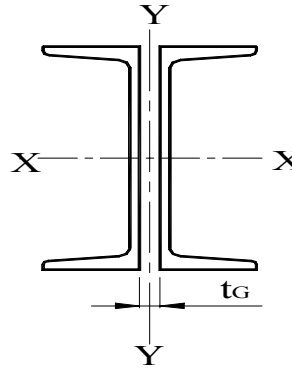

Sec. No.	Weight kg/m`	Area cm <sup>2</sup>	A <sub>web</sub> cm <sup>2</sup>	Axis X-X			Axis Y-Y								
				l <sub>x</sub> cm <sup>4</sup>	S <sub>x</sub> cm <sup>3</sup>	r <sub>x</sub> cm	l <sub>y</sub>	S <sub>y</sub>	r <sub>y</sub>	l <sub>y</sub>	S <sub>y</sub>	r <sub>y</sub>	l <sub>y</sub>	S <sub>y</sub>	r <sub>y</sub>
							t <sub>G</sub> = 8 mm			t <sub>G</sub> = 10 mm			t <sub>G</sub> = 12 mm		
30x15	3.48	4.42	1.68	5.06	3.38	1.07	4.50	2.37	1.01	5.36	2.68	1.10	6.30	3.00	1.19
30	8.54	10.88	1.60	12.78	8.52	1.08	42.47	11.48	1.98	46.30	12.19	2.06	50.35	12.91	2.15
40x20	5.74	7.32	2.90	15.16	7.58	1.44	10.66	4.44	1.21	12.30	4.92	1.30	14.09	5.42	1.39
40	9.74	12.42	2.60	28.20	14.10	1.50	50.53	12.96	2.02	54.95	13.74	2.10	59.62	14.54	2.19
50x25	7.72	9.84	3.80	33.20	13.46	1.85	19.39	6.69	1.40	21.87	7.29	1.49	24.54	7.92	1.58
50	11.18	14.24	3.60	52.80	21.20	1.92	62.85	14.96	2.10	68.04	15.82	2.19	73.50	16.71	2.27
60	10.14	12.92	5.76	63.20	21.00	2.21	31.19	9.17	1.55	34.71	9.92	1.64	38.48	10.69	1.73
65	14.18	18.06	5.50	115.0	35.40	2.52	88.02	19.14	2.21	94.78	20.17	2.29	101.89	21.23	2.38
70	13.46	17.14	6.84	122.2	35.00	2.67	79.57	18.09	2.15	85.98	19.11	2.24	92.74	20.16	2.33
80	17.28	22.00	7.68	212.0	53.00	3.10	114.10	23.28	2.28	122.5	24.49	2.36	131.3	25.74	2.44
100	21.20	27.00	9.96	412.0	82.40	3.91	161.27	29.86	2.44	172.1	31.29	2.52	183.4	32.75	2.61
120	26.80	34.00	14.28	728.0	121.4	4.62	222.40	37.69	2.56	236.3	39.39	2.64	251.0	41.14	2.72
140	32.00	40.80	16.80	1210	172.8	5.45	314.00	49.06	2.77	332.0	51.07	2.85	350.7	53.14	2.93
160	37.60	48.00	20.85	1850	232.0	6.21	411.44	59.63	2.93	433.4	61.92	3.00	456.4	64.28	3.08
180	44.00	56.00	25.28	2700	300.0	6.95	529.41	71.54	3.07	556.0	74.13	3.15	583.6	76.79	3.23
200	50.60	64.40	30.09	3820	382.0	7.70	670.04	84.82	3.23	701.7	87.72	3.30	734.7	90.70	3.38
220	58.80	74.80	35.10	5380	490.0	8.48	876.58	104.4	3.42	915.3	107.7	3.50	955.6	111.1	3.57
240	66.40	84.60	40.66	7200	600.0	9.22	1081.2	121.5	3.57	1126.5	125.2	3.65	1173.6	129.0	3.72
260	75.80	96.60	46.40	9640	742.0	9.99	1369.9	145.7	3.77	1424.1	149.9	3.84	1480.4	154.2	3.91
280	83.60	106.60	50.00	12560	896.0	10.90	1713.2	173.0	4.01	1776.7	177.7	4.08	1842.3	182.4	4.16
300	92.40	117.60	53.60	16060	1070	11.70	2120.1	203.9	4.25	2194.2	209.0	4.32	2270.7	214.2	4.39
320	119.00	151.60	79.80	21740	1358	12.10	2558.4	246.0	4.11	2650.9	252.5	4.18	2746.4	259.1	4.26
350	121.20	154.60	89.04	25680	1468	12.90	2352.1	226.2	3.90	2440.2	232.4	3.97	2531.4	238.8	4.05
380	126.20	160.80	93.96	31520	1658	14.00	2472.7	233.3	3.92	2563.7	239.6	3.99	2658.0	246.1	4.07
400	143.60	183.00	101.92	40700	2040	14.90	3394.4	297.8	4.31	3507.8	305.0	4.38	3624.9	312.5	4.45

# TWO CHANNELS (U.P.N.) TOE to TOE

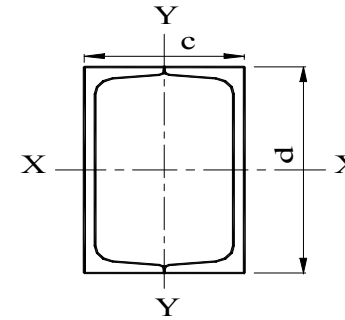

Sec. No.	Weight kg/m`	Area cm <sup>2</sup>	A <sub>web</sub> cm <sup>2</sup>	Axis X-X			Axis Y-Y (toe to toe)			Axis Y-Y (c=d)		
				I <sub>x</sub> cm <sup>4</sup>	S <sub>x</sub> cm <sup>3</sup>	r <sub>x</sub> cm	I <sub>y</sub> cm <sup>4</sup>	S <sub>y</sub> cm <sup>3</sup>	r <sub>y</sub> cm	I <sub>y</sub> cm <sup>4</sup>	S <sub>y</sub> cm <sup>3</sup>	r <sub>y</sub> cm
30x15	3.48	4.42	1.68	5.06	3.38	1.07	5.00	3.34	1.06	5.00	3.34	1.06
30	8.54	10.88	1.60	12.78	8.52	1.08	53.75	16.29	2.22	N.A.		
40x20	5.74	7.32	2.90	15.16	7.58	1.44	15.23	7.61	1.44	15.23	7.61	1.44
40	9.74	12.42	2.60	28.20	14.10	1.50	71.84	20.53	2.41	N.A.		
50x25	7.72	9.84	3.80	33.20	13.46	1.85	33.08	13.23	1.83	33.08	13.23	1.83
50	11.18	14.24	3.60	52.80	21.20	1.92	102.3	26.93	2.68	N.A.		
60	10.14	12.92	5.76	63.20	21.00	2.21	65.46	21.82	2.25	65.46	21.82	2.25
65	14.18	18.06	5.50	115.0	35.40	2.52	167.8	39.95	3.05	N.A.		
70	13.46	17.14	6.84	122.2	35.00	2.67	136.9	34.22	2.83	N.A.		
80	17.28	22.00	7.68	212.0	53.00	3.10	243.5	54.10	3.33	N.A.		
100	21.20	27.00	9.96	412.0	82.40	3.91	380.0	75.99	3.75	380.0	75.99	3.75
120	26.80	34.00	14.28	728.0	121.4	4.62	603.5	109.7	4.21	744.6	124.1	4.68
140	32.00	40.80	16.80	1210	172.8	5.45	862.4	143.7	4.60	1250	178.6	5.53
160	37.60	48.00	20.85	1850	232.0	6.21	1213	186.6	5.03	1992	249.0	6.44
180	44.00	56.00	25.28	2700	300.0	6.95	1673	239.0	5.47	3035	337.2	7.36
200	50.60	64.40	30.09	3820	382.0	7.70	2237	298.3	5.89	4407	440.7	8.27
220	58.80	74.80	35.10	5380	490.0	8.48	2963	370.3	6.29	6266	569.6	9.15
240	66.40	84.60	40.66	7200	600.0	9.22	3822	449.6	6.72	8571	714.3	10.07
260	75.80	96.60	46.40	9640	742.0	9.99	4893	543.7	7.12	11570	890.0	10.94
280	83.60	106.60	50.00	12560	896.0	10.90	5977	629.1	7.49	14822	1059	11.79
300	92.40	117.60	53.60	16060	1070	11.70	7257	725.7	7.86	18782	1252	12.64
320	119.00	151.60	79.80	21740	1358	12.10	9496	949.6	7.91	28415	1776	13.69
350	121.20	154.60	89.04	25680	1468	12.90	10070	1007	8.07	36390	2079	15.34
380	126.20	160.80	93.96	31520	1658	14.00	11063	1085	8.29	45647	2402	16.85
400	143.60	183.00	101.92	40700	2040	14.90	14451	1314	8.89	56779	2839	17.61

N.A.= Section is not available with the specified configuration.

## SYMMETRICAL WELDED I- SECTIONS

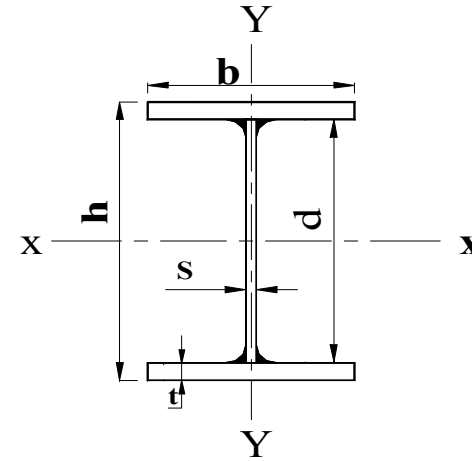

depth h	Web		Flange		Weight	Area	$A_{web}$	Axis x-x			Axis y-y			Surface Area	
	d	s	b	t				$I_x$	$S_x$	$r_x$	$I_y$	$S_y$	$r_y$	$U_m$	$U_t$
mm	mm	mm	mm	mm	kg/m`	cm <sup>2</sup>	cm <sup>2</sup>	cm <sup>4</sup>	cm <sup>3</sup>	cm	cm <sup>4</sup>	cm <sup>3</sup>	cm	$\times 10^{-2} m^2/m'$	m <sup>2</sup> /t
210	200	5	140	5	18.84	24.0	10.0	1805	172	8.67	228.9	32.7	3.09	97.00	51.49
212	200	5	140	6	21.04	26.8	10.0	2116	200	8.89	274.6	39.2	3.20	97.40	46.30
214	200	5	140	7	23.24	29.6	10.0	2434	227	9.07	320.3	45.8	3.29	97.80	42.09
260	250	5	140	5	20.80	26.5	12.5	2927	225	10.51	228.9	32.7	2.94	107.00	51.44
262	250	5	140	6	23.00	29.3	12.5	3404	260	10.78	274.7	39.2	3.06	107.40	46.69
264	250	5	140	7	25.20	32.1	12.5	3888	295	11.01	320.4	45.8	3.16	107.80	42.78
262	250	5	165	6	25.36	32.3	12.5	3896	297	10.98	449.5	54.5	3.73	117.40	46.30
264	250	5	165	7	27.95	35.6	12.5	4466	338	11.20	524.3	63.6	3.84	117.80	42.15
340	330	5	140	5	23.94	30.5	16.5	5426	319	13.34	229.0	32.7	2.74	123.00	51.37
342	330	5	140	6	26.14	33.3	16.5	6240	365	13.69	274.7	39.2	2.87	123.40	47.21
344	330	5	140	7	28.34	36.1	16.5	7063	411	13.99	320.5	45.8	2.98	123.80	43.69
342	330	5	165	6	28.50	36.3	16.5	7086	414	13.97	449.6	54.5	3.52	133.40	46.81
344	330	5	165	7	31.09	39.6	16.5	8057	468	14.26	524.4	63.6	3.64	133.80	43.04
346	330	5	165	8	33.68	42.9	16.5	9039	522	14.52	599.3	72.6	3.74	134.20	39.85
344	330	5	200	7	34.93	44.5	16.5	9448	549	14.57	933.7	93.4	4.58	147.80	42.31
346	330	5	200	8	38.07	48.5	16.5	10639	615	14.81	1067.0	106.7	4.69	148.20	38.93

## SYMMETRICAL WELDED I- SECTIONS

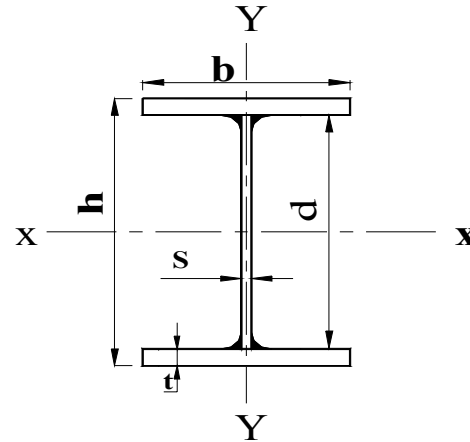

depth h	Web		Flange		Weight	Area	$A_{web}$	Axis x-x			Axis y-y			Surface Area	
	d	s	b	t				$I_x$	$S_x$	$r_x$	$I_y$	$S_y$	$r_y$	$U_m$	$U_t$
mm	mm	mm	mm	mm	kg/m <sup>1</sup>	cm <sup>2</sup>	cm <sup>2</sup>	cm <sup>4</sup>	cm <sup>3</sup>	cm	cm <sup>4</sup>	cm <sup>3</sup>	cm	x10 <sup>-2</sup> m <sup>2</sup> /m <sup>1</sup>	m <sup>2</sup> /t
414	400	5	140	7	31.09	39.6	20.0	10784	521	16.50	320.6	45.8	2.85	137.80	44.33
412	400	5	165	6	31.24	39.8	20.0	10827	526	16.49	449.7	54.5	3.36	147.40	47.18
414	400	5	165	7	33.83	43.1	20.0	12234	591	16.85	524.6	63.6	3.49	147.80	43.68
416	400	5	165	8	36.42	46.4	20.0	13655	656	17.15	599.4	72.7	3.59	148.20	40.69
414	400	5	200	7	37.68	48.0	20.0	14263	689	17.24	933.8	93.4	4.41	161.80	42.94
416	400	5	200	8	40.82	52.0	20.0	15985	769	17.53	1067.1	106.7	4.53	162.20	39.74
420	400	5	200	10	47.10	60.0	20.0	19480	928	18.02	1333.8	133.4	4.71	163.00	34.61
514	500	6	140	7	38.94	49.6	30.0	18846	733	19.49	321.0	45.9	2.54	157.60	40.48
514	500	6	165	7	41.68	53.1	30.0	21096	821	19.93	525.0	63.6	3.14	167.60	40.21
516	500	6	165	8	44.27	56.4	30.0	23284	902	20.32	599.9	72.7	3.26	168.00	37.95
514	500	6	200	7	45.53	58.0	30.0	24245	943	20.45	934.2	93.4	4.01	181.60	39.89
516	500	6	200	8	48.67	62.0	30.0	26897	1043	20.83	1067.6	106.8	4.15	182.00	37.39
420	500	6	200	10	54.95	70.0	30.0	32263	1241	21.47	1334.2	133.4	4.37	182.80	33.27
520	500	6	250	10	62.80	80.0	30.0	38767	1491	22.01	2605.1	208.4	5.71	202.80	32.29
524	500	6	250	12	70.65	90.0	30.0	45579	1740	22.50	3125.9	250.1	5.89	203.60	28.82

# SYMMETRICAL WELDED I- SECTIONS

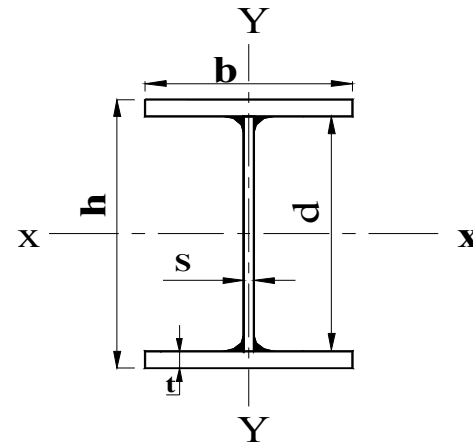

depth	Web		Flange		Weight	Area	A <sub>web</sub>	Axis x-x			Axis y-y			Surface Area	
	h	d	s	b				t	I <sub>x</sub>	S <sub>x</sub>	r <sub>x</sub>	I <sub>y</sub>	S <sub>y</sub>	r <sub>y</sub>	U <sub>m</sub>
mm	mm	mm	mm	mm	kg/m`	cm <sup>2</sup>	cm <sup>2</sup>	cm <sup>4</sup>	cm <sup>3</sup>	cm	cm <sup>4</sup>	cm <sup>3</sup>	cm	x10 <sup>-2</sup> m <sup>2</sup> /m\	m <sup>2</sup> /t
614	600	7	165	7	51.10	65.1	42.0	33879	1104	22.81	526	64	2.84	187.40	36.67
614	600	7	200	7	54.95	70.0	42.0	38393	1251	23.42	935	94	3.65	201.40	36.65
616	600	7	200	8	58.09	74.0	42.0	42175	1369	23.87	1068	107	3.80	201.80	34.74
620	600	7	200	10	64.37	82.0	42.0	49813	1607	24.65	1335	134	4.03	202.60	31.47
620	600	7	250	10	72.22	92.0	42.0	59117	1907	25.35	2606	208	5.32	222.60	30.82
624	600	7	250	12	80.07	102.0	42.0	68789	2205	25.97	3127	250	5.54	223.40	27.90
624	600	7	330	12	95.14	121.2	42.0	86769	2781	26.76	7189	436	7.70	255.40	26.84
674	660	7	165	7	54.40	69.3	46.2	42464	1260	24.75	526	64	2.75	199.40	36.65
676	660	7	165	8	56.99	72.6	46.2	46223	1368	25.23	601	73	2.88	199.80	35.06
674	660	7	200	7	58.25	74.2	46.2	47914	1422	25.41	935	94	3.55	213.40	36.64
676	660	7	200	8	61.39	78.2	46.2	52470	1552	25.90	1069	107	3.70	213.80	34.83
680	660	7	200	10	67.67	86.2	46.2	61664	1814	26.75	1335	134	3.94	214.60	31.71
680	660	7	250	10	75.52	96.2	46.2	72887	2144	27.53	2606	208	5.20	234.60	31.07
684	660	7	250	12	83.37	106.2	46.2	84515	2471	28.21	3127	250	5.43	235.40	28.24
680	660	7	330	10	88.08	112.2	46.2	90845	2672	28.45	5991	363	7.31	266.60	30.27



## SYMMETRICAL WELDED I- SECTIONS

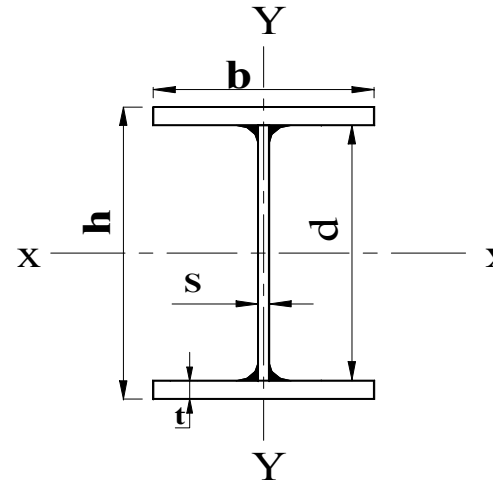

depth	Web		Flange		Weight	Area	$A_{web}$	Axis x-x			Axis y-y			Surface Area	
	h	d	s	t				$I_x$	$S_x$	$r_x$	$I_y$	$S_y$	$r_y$	$U_m$	$U_t$
mm	mm	mm	mm	mm	kg/m	cm <sup>2</sup>	cm <sup>2</sup>	cm <sup>4</sup>	cm <sup>3</sup>	cm	cm <sup>4</sup>	cm <sup>3</sup>	cm	$\times 10^{-2} m^2/m$	m <sup>2</sup> /t
764	750	7	200	7	63.19	80.5	52.5	64724	1694	28.36	935.5	93.5	3.41	231.40	36.62
766	750	7	200	8	66.33	84.5	52.5	70576	1843	28.90	1068.8	106.9	3.56	231.80	34.95
770	750	7	200	10	72.61	92.5	52.5	82373	2140	29.84	1335.5	133.5	3.80	232.60	32.03
770	750	7	250	10	80.46	102.5	52.5	96814	2515	30.73	2606.3	208.5	5.04	252.60	31.39
774	750	7	250	12	88.31	112.5	52.5	111713	2887	31.51	3127.1	250.2	5.27	253.40	28.69
770	750	7	330	10	93.02	118.5	52.5	119919	3115	31.81	5991.6	363.1	7.11	284.60	30.59
774	750	7	330	12	103.38	131.7	52.5	139586	3607	32.56	7189.5	435.7	7.39	285.40	27.61
764	750	8	200	7	69.08	88.0	60.0	68240	1786	27.85	936.5	93.7	3.26	231.20	33.47
766	750	8	200	8	72.22	92.0	60.0	74092	1935	28.38	1069.9	107.0	3.41	231.60	32.07
770	750	8	200	10	78.50	100.0	60.0	85888	2231	29.31	1336.5	133.7	3.66	232.40	29.61
770	750	8	250	10	86.35	110.0	60.0	100329	2606	30.20	2607.4	208.6	4.87	252.40	29.23
774	750	8	250	12	94.20	120.0	60.0	115229	2977	30.99	3128.2	250.3	5.11	253.20	26.88
770	750	8	330	10	98.91	126.0	60.0	123435	3206	31.30	5992.7	363.2	6.90	284.40	28.75
774	750	8	330	12	109.27	139.2	60.0	143102	3698	32.06	7190.6	435.8	7.19	285.20	26.10

## SYMMETRICAL WELDED I- SECTIONS

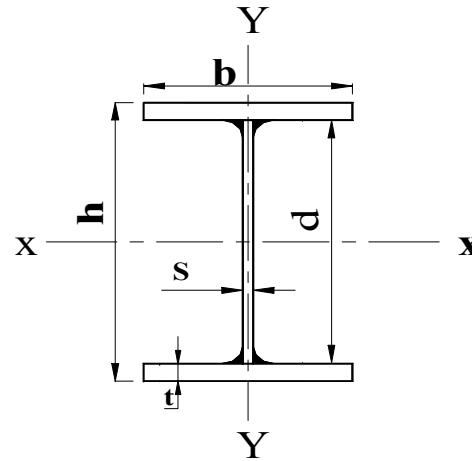

depth h	Web		Flange		Weight	Area cm <sup>2</sup>	A <sub>web</sub> cm <sup>2</sup>	Axis x-x			Axis y-y			Surface Area	
	d	s	b	t				I <sub>x</sub> cm <sup>4</sup>	S <sub>x</sub> cm <sup>3</sup>	r <sub>x</sub> cm	I <sub>y</sub> cm <sup>4</sup>	S <sub>y</sub> cm <sup>3</sup>	r <sub>y</sub> cm	U <sub>m</sub> x10 <sup>-2</sup> m <sup>2</sup> /m <sup>l</sup>	U <sub>t</sub> m <sup>2</sup> /t
mm	mm	mm	mm	mm	kg/m <sup>l</sup>	cm <sup>2</sup>	cm <sup>2</sup>	cm <sup>4</sup>	cm <sup>3</sup>	cm	cm <sup>4</sup>	cm <sup>3</sup>	cm	x10 <sup>-2</sup> m <sup>2</sup> /m <sup>l</sup>	m <sup>2</sup> /t
814	800	7	200	7	65.94	84.0	56.0	75455	1854	29.97	935.6	93.6	3.34	241.40	36.61
816	800	7	200	8	69.08	88.0	56.0	82097	2012	30.54	1069.0	106.9	3.49	241.80	35.00
820	800	7	200	10	75.36	96.0	56.0	95480	2329	31.54	1335.6	133.6	3.73	242.60	32.19
820	800	7	250	10	83.21	106.0	56.0	111883	2729	32.49	2606.5	208.5	4.96	262.60	31.56
824	800	7	250	12	91.06	116.0	56.0	128775	3126	33.32	3127.3	250.2	5.19	263.40	28.93
824	800	7	330	12	106.13	135.2	56.0	160426	3894	34.45	7189.7	435.7	7.29	295.40	27.83
828	800	7	330	14	116.49	148.4	56.0	182941	4419	35.11	8387.6	508.3	7.52	296.20	25.43
814	800	8	200	7	72.22	92.0	64.0	79722	1959	29.44	936.7	93.7	3.19	241.20	33.40
816	800	8	200	8	75.36	96.0	64.0	86364	2117	29.99	1070.1	107.0	3.34	241.60	32.06
820	800	8	200	10	81.64	104.0	64.0	99747	2433	30.97	1336.7	133.7	3.59	242.40	29.69
820	800	8	250	10	89.49	114.0	64.0	116150	2833	31.92	2607.6	208.6	4.78	262.40	29.32
824	800	8	250	12	97.34	124.0	64.0	133042	3229	32.76	3128.4	250.3	5.02	263.20	27.04
824	800	8	330	12	112.41	143.2	64.0	164693	3997	33.91	7190.8	435.8	7.09	295.20	26.26
828	800	8	330	14	122.77	156.4	64.0	187208	4522	34.60	8388.7	508.4	7.32	296.00	24.11

# SYMMETRICAL WELDED I- SECTIONS

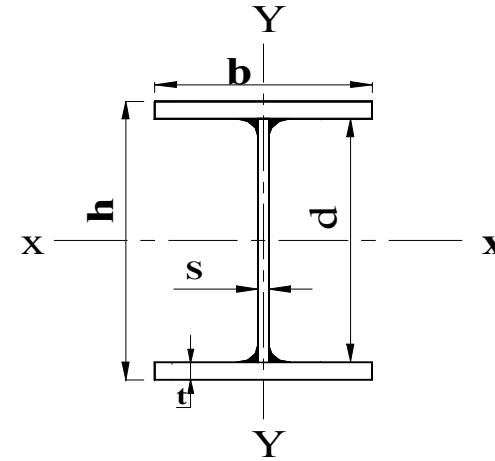

depth	Web		Flange		Weight	Area	$A_{web}$	Axis x-x			Axis y-y			Surface Area	
	h	d	s	b				t	$I_x$	$S_x$	$r_x$	$I_y$	$S_y$	$r_y$	$U_m$
mm	mm	mm	mm	mm	kg/m`	cm <sup>2</sup>	cm <sup>2</sup>	cm <sup>4</sup>	cm <sup>3</sup>	cm	cm <sup>4</sup>	cm <sup>3</sup>	cm	x10 <sup>-2</sup> m <sup>2</sup> /m <sup>1</sup>	m <sup>2</sup> /t
1014	1000	10	200	7	100.48	128.0	100.0	154318	3044	34.72	941.7	94.2	2.71	280.80	27.95
1016	1000	10	200	8	103.62	132.0	100.0	164620	3241	35.31	1075.0	107.5	2.85	281.20	27.14
1020	1000	10	200	10	109.90	140.0	100.0	185347	3634	36.39	1341.7	134.2	3.10	282.00	25.66
1020	1000	10	250	10	117.75	150.0	100.0	210850	4134	37.49	2612.5	209.0	4.17	302.00	25.65
1024	1000	10	250	12	125.60	160.0	100.0	236962	4628	38.48	3133.3	250.7	4.43	302.80	24.11
1020	1000	10	330	10	130.31	166.0	100.0	251655	4934	38.94	5997.8	363.5	6.01	334.00	25.63
1024	1000	10	330	12	140.67	179.2	100.0	286123	5588	39.96	7195.7	436.1	6.34	334.80	23.80
1028	1000	10	330	14	151.03	192.4	100.0	320862	6242	40.84	8393.6	508.7	6.60	335.60	22.22

# UNSYMMETRICAL WELDED I-SECTIONS

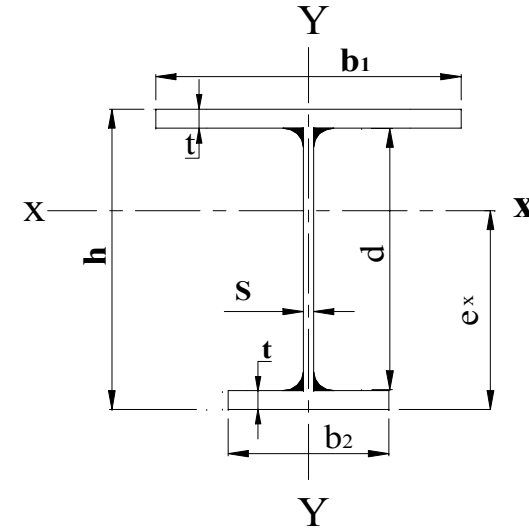

depth	Web		Flange			Weight	Area	$A_{web}$	Axis x-x					Axis y-y				Surface Area	
	h	d	s	$b_1$	$b_2$				t	$I_x$	$S_{xt}$	$S_{xb}$	$r_x$	$e_x$	$I_y$	$S_y$	$r_y$	$S_{yupper\ flange}$	$U_m$
mm	mm	mm	mm	mm	mm	kg/m	cm <sup>2</sup>	cm <sup>2</sup>	cm <sup>4</sup>	cm <sup>3</sup>	cm <sup>3</sup>	cm	cm	cm <sup>4</sup>	cm <sup>3</sup>	cm	cm <sup>3</sup>	x10 <sup>2</sup> m <sup>2</sup> /m	m <sup>2</sup> /t
224	200	5	140	70	12	27.63	35.2	10.0	2943	339	214	9.14	13.73	309	44	2.96	39.20	85.80	31.05
224	200	5	200	100	12	36.11	46.0	10.0	4031	478	289	9.36	13.97	900	90	4.42	80.00	103.80	28.75
274	250	5	140	70	12	29.59	37.7	12.5	4657	432	280	11.11	16.62	309	44	2.86	39.20	95.80	32.37
274	250	5	250	140	12	46.55	59.3	12.5	8184	759	493	11.75	16.62	1837	147	5.57	125.00	131.80	28.31
324	300	5	200	100	12	40.04	51.0	15.0	9203	735	463	13.43	19.87	900	90	4.20	80.00	123.80	30.92
324	300	5	250	140	12	48.51	61.8	15.0	11834	920	606	13.84	19.53	1837	147	5.45	125.00	141.80	29.23
354	330	5	200	100	12	41.21	52.5	16.5	11226	814	520	14.62	21.61	900	90	4.14	80.00	129.80	31.50
354	330	5	250	140	12	49.69	63.3	16.5	14383	1018	676	15.07	21.27	1837	147	5.39	125.00	147.80	29.74
358	330	5	300	140	14	61.31	78.1	16.5	17831	1375	781	15.11	22.83	3470	231	6.67	210.00	158.60	25.87
358	330	5	330	165	14	67.35	85.8	16.5	20171	1520	895	15.33	22.53	4717	286	7.41	254.10	169.60	25.18
428	400	5	250	140	14	58.56	74.6	20.0	24709	1443	962	18.20	25.67	2143	171	5.36	145.83	162.60	27.77
428	400	5	300	165	14	66.80	85.1	20.0	28773	1712	1107	18.39	26.00	3674	245	6.57	210.00	177.60	26.59
432	400	5	330	165	16	77.87	99.2	20.0	33909	2111	1250	18.49	27.14	5391	327	7.37	290.40	184.40	23.68
432	400	5	400	200	16	91.06	116.0	20.0	40401	2547	1478	18.66	27.34	9600	480	9.10	426.67	205.40	22.56
532	500	5	250	140	16	68.61	87.4	25.0	44398	2074	1396	22.54	31.80	2450	196	5.29	166.67	183.40	26.73
532	500	5	300	165	16	78.03	99.4	25.0	51623	2459	1603	22.79	32.21	4199	280	6.50	240.00	198.40	25.43
536	500	5	330	165	18	89.57	114.1	25.0	59816	2982	1783	22.90	33.54	6065	368	7.29	326.70	205.20	22.91
536	500	5	400	200	18	104.41	133.0	25.0	71148	3595	2104	23.13	33.81	10801	540	9.01	480.00	226.20	21.67
540	500	5	500	250	20	137.38	175.0	25.0	97001	4956	2817	23.54	34.43	23438	938	11.57	833.33	257.00	18.71

## UNSYMMETRICAL WELDED I-SECTIONS

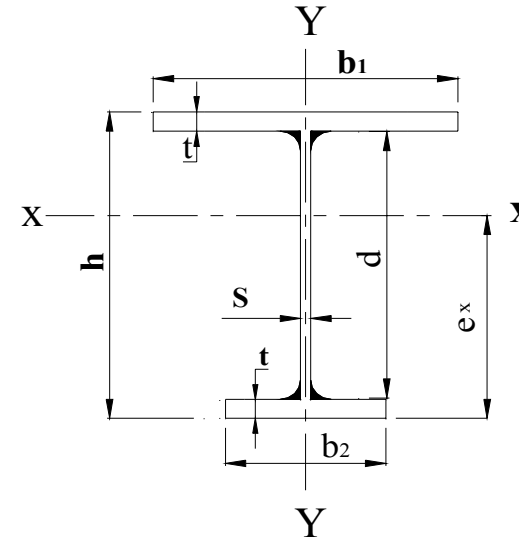

depth	Web			Flange			Weight	Area	$A_{web}$	Axis x-x					Axis y-y				Surface Area	
	h	d	s	$b_1$	$b_2$	t				$I_x$	$S_{xt}$	$S_{xb}$	$r_x$	$e_x$	$I_y$	$S_y$	$r_y$	$S_{y \text{ upper flange}}$	$U_m$	$U_t$
mm	mm	mm	mm	mm	mm	mm	kg/m	cm <sup>2</sup>	cm <sup>2</sup>	cm <sup>4</sup>	cm <sup>3</sup>	cm <sup>3</sup>	cm	cm	cm <sup>4</sup>	cm <sup>3</sup>	cm	cm <sup>3</sup>	x10 <sup>-2</sup> m <sup>2</sup> /m	m <sup>2</sup> /t
632	600	6	300	165	16	86.66	110.4	36.0	77386	3026	2057	26.48	37.63	4200	280	6.17	240	218.20	25.18	
636	600	6	330	165	18	98.20	125.1	36.0	89165	3645	2278	26.70	39.14	6065	368	6.96	327	225.00	22.91	
636	600	6	400	200	18	113.04	144.0	36.0	105355	4376	2666	27.05	39.53	10801	540	8.66	480	246.00	21.76	
640	600	6	400	250	20	130.31	166.0	36.0	130563	4946	3472	28.05	37.60	13272	664	8.94	533	256.80	19.71	
640	600	6	500	250	20	146.01	186.0	36.0	142083	6004	3523	27.64	40.33	23439	938	11.23	833	276.80	18.96	
696	660	7	300	165	18	101.97	129.9	46.2	107758	3787	2619	28.80	41.14	4726	315	6.03	270	230.80	22.63	
700	660	7	330	165	20	113.98	145.2	46.2	122578	4495	2869	29.06	42.73	6740	408	6.81	363	237.60	20.85	
700	660	7	400	200	20	130.47	166.2	46.2	144402	5385	3344	29.48	43.18	12002	600	8.50	533	258.60	19.82	
704	660	7	400	250	22	148.52	189.2	46.2	176417	6031	4287	30.54	41.15	14600	730	8.78	587	269.40	18.14	
704	660	7	500	250	22	165.79	211.2	46.2	192046	7297	4357	30.15	44.08	25783	1031	11.05	917	289.40	17.46	
786	750	7	330	165	18	111.16	141.6	52.5	146831	4699	3101	32.20	47.35	6067	368	6.55	327	254.80	22.92	
786	750	7	400	200	18	125.99	160.5	52.5	171984	5604	3590	32.73	47.91	10802	540	8.20	480	275.80	21.89	
790	750	7	400	250	20	143.26	182.5	52.5	210035	6332	4583	33.92	45.83	13273	664	8.53	533	286.60	20.01	
794	750	7	500	250	22	170.74	217.5	52.5	249797	8344	5050	33.89	49.46	25783	1031	10.89	917	307.40	18.00	
1036	1000	10	330	165	18	148.44	189.1	100.0	302113	6897	5053	39.97	59.79	6073	368	5.67	327	304.20	20.49	
1040	1000	10	400	200	20	172.70	220.0	100.0	376577	8814	6146	41.37	61.27	12008	600	7.39	533	326.00	18.88	
1044	1000	10	400	250	22	190.76	243.0	100.0	445092	9834	7526	42.80	59.14	14606	730	7.75	587	336.80	17.66	
1044	1000	10	500	250	22	208.03	265.0	100.0	484442	11647	7713	42.76	62.81	25790	1032	9.87	917	356.80	17.15	

# BUILT-UP SECTION IPE +Channel (U.P.N.)

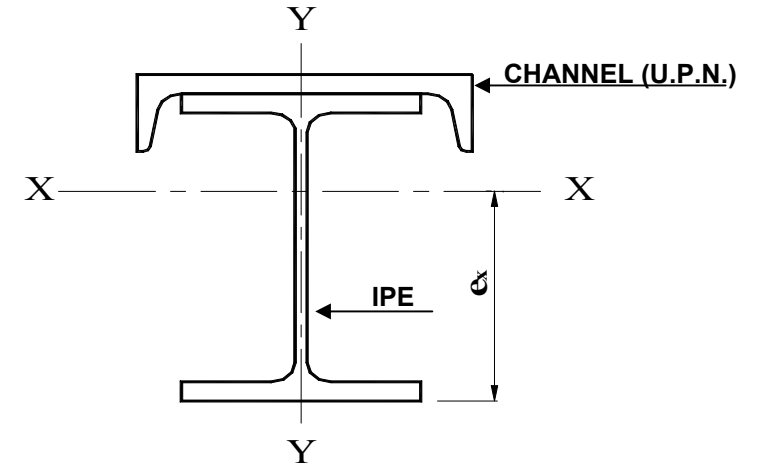

IPE NO.	CHANNEL NO.	Weight kg/m <sup>1</sup>	Area cm <sup>2</sup>	A <sub>web</sub> cm <sup>2</sup>	AXIS X-X					AXIS Y-Y				
					I <sub>x</sub> cm <sup>4</sup>	S <sub>xb</sub> cm <sup>3</sup>	S <sub>xt</sub> cm <sup>3</sup>	r <sub>x</sub> cm	e <sub>x</sub> cm	I <sub>y</sub> cm <sup>4</sup>	S <sub>y</sub> cm <sup>3</sup>	r <sub>y</sub> cm	I <sub>y</sub> upper flange cm <sup>4</sup>	S <sub>y</sub> upper flange cm <sup>3</sup>
200	160	41.20	52.50	10.25	3060	217	458	7.63	14.07	1067	133.38	4.51	996	124.50
	180	44.40	56.50		3168	220	495	7.49	14.40	1492	165.78	5.14	1421	157.89
	200	47.70	60.70		3269	223	531	7.34	14.69	2052	205.20	5.81	1981	198.10
220	160	45.00	57.40	11.89	4227	279	556	8.58	15.14	1130	141.25	4.44	1028	128.44
	180	48.20	61.40		4371	282	599	8.44	15.51	1555	172.78	5.03	1453	161.39
	220	55.60	70.80		4648	288	689	8.10	16.16	2895	263.18	6.39	2793	253.86
240	180	52.70	67.10	13.66	5935	359	719	9.41	16.54	1634	181.56	4.93	1492	165.78
	200	56.00	71.30		6113	362	768	9.26	16.90	2194	219.40	5.55	2052	205.20
	240	63.90	81.40		6473	368	877	8.92	17.57	3884	323.67	6.91	3742	311.83
270	200	61.40	78.10	16.47	8820	474	952	10.63	18.59	2330	233.00	5.46	2120	212.00
	240	69.30	88.20		9325	482	1086	10.28	19.36	4020	335.00	6.75	3810	317.50
	280	77.90	99.20		9600	484	1173	9.84	19.82	6700	478.57	8.22	6490	463.57
300	200	67.50	86.00	19.78	12366	613	1159	11.99	20.18	2514	251.40	5.41	2212	221.20
	240	75.40	96.10		13066	621	1318	11.66	21.04	4204	350.33	6.61	3902	325.17
	300	88.40	112.60		13825	630	1527	11.08	21.95	8634	575.60	8.76	8332	555.47
330	220	78.50	100.00	23.03	17419	784	1490	13.20	22.21	3478	316.18	5.90	3084	280.36
	260	87.00	110.90		18336	794	1681	12.86	23.09	5608	431.38	7.11	5214	401.08
	320	108.60	138.40		20393	820	2142	12.14	24.88	11658	728.63	9.18	11264	704.00

## BUILT-UP SECTION IPE +Channel (U.P.N.)

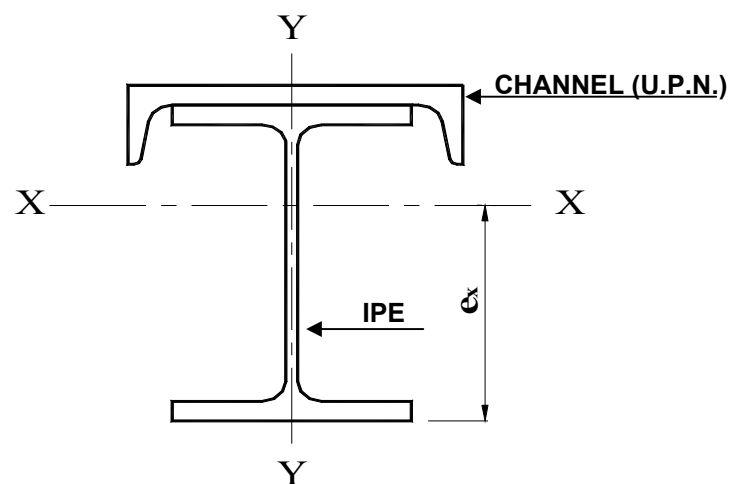

IPE NO.	CHANNEL NO.	Weight kg/m <sup>1</sup>	Area cm <sup>2</sup>	$A_{web}$ cm <sup>2</sup>	AXIS X-X					AXIS Y-Y				
					$I_x$	$S_{xb}$	$S_{xt}$	$r_x$	$e_x$	$I_y$	$S_y$	$r_y$	$I_{y \text{ upper flange}}$	$S_{y \text{ upper flange}}$
					cm <sup>4</sup>	cm <sup>3</sup>	cm <sup>3</sup>	cm	cm	cm <sup>4</sup>	cm <sup>3</sup>	cm	cm <sup>4</sup>	cm <sup>3</sup>
360	240	90.30	115.00	26.77	23994	994	1875	14.44	24.15	4640	386.67	6.35	4120	343.33
	280	98.90	126.00		24800	997	2046	14.03	24.88	7320	522.86	7.62	6800	485.71
	350	117.70	150.00		27667	1034	2600	13.58	26.76	13880	793.14	9.62	13360	763.43
400	240	99.50	126.80	32.08	33256	1267	2262	16.19	26.24	4920	410.00	6.23	4260	355.00
	320	125.80	160.30		37849	1310	3025	15.37	28.89	12190	761.88	8.72	11530	720.63
	400	138.10	176.00		39420	1325	3383	14.97	29.75	21670	1083.50	11.10	21010	1050.50
450	260	115.50	147.10	39.56	48555	1649	2932	18.17	29.44	6500	500.00	6.65	5660	435.38
	320	137.10	174.60		53797	1695	3671	17.55	31.75	12550	784.38	8.48	11710	731.88
	400	149.40	190.30		56037	1713	4096	17.16	32.72	22030	1101.50	10.76	21190	1059.50
500	260	128.60	164.30	47.74	67574	2115	3547	20.28	31.95	6960	535.38	6.51	5890	453.08
	320	150.20	191.80		74765	2173	4399	19.74	34.41	13010	813.13	8.24	11940	746.25
	400	162.50	207.50		77899	2196	4891	19.38	35.47	22490	1124.50	10.41	21420	1071.00
550	280	147.80	187.30	57.23	92823	2665	4385	22.26	34.83	8950	639.29	6.91	7615	543.93
	320	165.50	209.80		101204	2735	5217	21.96	37.00	13540	846.25	8.03	12205	762.81
	400	177.80	225.50		105432	2764	5778	21.62	38.15	23020	1151.00	10.10	21685	1084.25
600	300	168.20	214.80	67.44	126776	3359	5452	24.29	37.75	11420	761.33	7.29	9725	648.33
	350	182.60	233.30		136120	3437	6246	24.15	39.61	16230	927.43	8.34	14535	830.57
	400	193.80	247.50		140596	3461	6769	23.83	40.63	23740	1187.00	9.79	22045	1102.25

# COLD FORMED SECTIONS

UNSTIFFENED CHANNEL

LIPPED CHANNEL

STRAIGHT LIPPED Z-CHANNEL

INCLINED LIPPED Z-CHANNEL



# UNSTIFFENED CHANNEL (COLD FORMED SECTION)

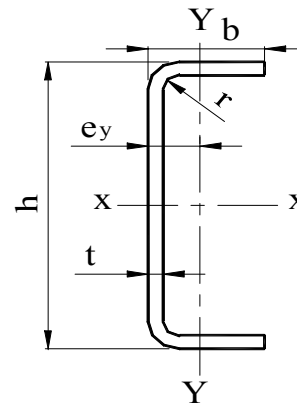

Dimensions				Weight	Area	$A_{web}$	Axis X-X			Axis Y-Y			
$h$	$b$	$t$	$r$				$I_x$	$S_x$	$r_x$	$I_y$	$S_y$	$r_y$	$e_y$
mm	mm	mm	mm	kg/m`	cm <sup>2</sup>	cm <sup>2</sup>	cm <sup>4</sup>	cm <sup>3</sup>	cm	cm <sup>4</sup>	cm <sup>3</sup>	cm	cm
30	25	4	8	1.99	2.54	0.88	2.87	1.91	1.06	1.28	0.89	0.71	1.06
40	20	4	8	1.99	2.54	1.28	4.80	2.40	1.38	0.73	0.58	0.54	0.73
40	24	4	8	2.24	2.86	1.28	5.84	2.92	1.43	1.35	0.90	0.69	0.90
50	25	4	8	2.62	3.34	1.68	10.80	4.32	1.80	1.73	1.05	0.72	0.85
50	35	4	8	3.25	4.20	1.68	15.03	6.01	1.91	4.78	2.14	1.07	1.27
60	30	4	8	3.24	4.14	2.08	20.30	6.77	2.22	3.29	1.62	0.89	0.97
65	38	4	8	3.90	4.98	2.28	30.71	9.45	2.48	6.82	2.68	1.17	1.25
70	25	4	8	3.25	4.14	2.48	25.40	7.26	2.48	2.00	1.13	0.70	0.73
80	45	4	8	4.81	6.14	2.88	58.81	14.70	3.10	12.05	3.91	1.40	1.41
100	50	4	8	5.76	7.34	3.68	109.40	21.88	3.86	17.67	5.00	1.56	1.46
120	60	4	8	7.01	8.94	4.48	195.80	32.63	4.68	31.50	7.34	1.88	1.71
140	65	4	8	7.96	10.14	5.28	300.13	42.88	5.44	41.54	8.78	2.02	1.77
160	65	4	8	8.58	10.94	6.08	411.28	51.41	6.13	43.37	8.95	1.99	1.65
180	80	4	8	10.06	12.94	6.88	637.23	70.80	7.02	80.45	13.60	2.49	2.09
200	80	4	8	10.78	13.74	7.68	816.04	81.60	7.71	83.13	13.80	2.46	1.98
200	100	4	8	12.04	15.34	7.68	969.70	96.97	7.95	154.37	21.17	3.17	2.71
60	40	3.6	8	3.51	4.48	1.90	24.48	8.16	2.34	7.02	2.66	1.25	1.36
60	40	4	8	3.87	4.94	2.08	26.58	8.86	2.32	7.64	2.92	1.24	1.38
80	40	2.25	8	2.61	3.32	1.70	32.33	8.08	3.12	5.24	1.83	1.26	1.14
80	40	2.5	8	2.89	3.68	1.88	35.52	8.88	3.11	5.75	2.02	1.25	1.15
80	40	3	8	3.43	4.37	2.22	41.66	10.42	3.09	6.75	2.39	1.24	1.18
80	40	4	8	4.50	5.74	2.88	53.04	13.26	3.04	8.60	3.09	1.22	1.22
80	50	5	7.5	6.32	8.05	3.50	77.30	19.33	3.10	19.55	5.85	1.56	1.66
100	40	3	8	3.91	4.97	2.82	70.96	14.19	3.78	7.31	2.48	1.21	1.05
100	40	4	8	5.13	6.54	3.68	90.97	18.19	3.73	9.33	3.21	1.19	1.09
100	50	5	8	7.10	9.05	4.50	131.83	26.37	3.82	21.32	6.10	1.53	1.51
120	60	4	8	7.01	8.94	4.48	195.80	32.63	4.68	31.50	7.35	1.88	1.71
140	63	4	8	7.83	9.98	5.28	292.73	41.82	5.42	38.05	8.27	1.95	1.70
160	63	4	8	8.46	10.78	6.08	401.54	50.19	6.10	39.70	8.43	1.92	1.59
180	75	4	8	9.84	12.54	6.88	606.25	67.36	6.95	67.20	12.01	2.32	1.90

# LIPPED CHANNEL (COLD FORMED SECTION)

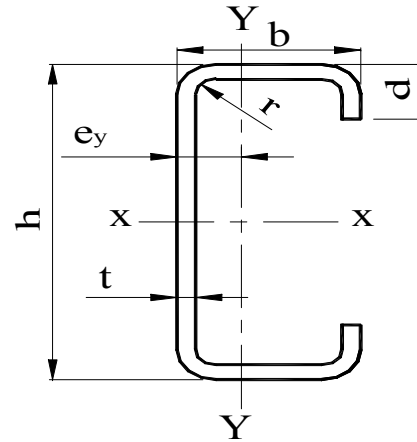

Dimensions					Weight	Area	$A_{web}$	Axis X-X			Axis Y-Y			
$h$	$b$	$d$	$t$	$r$				$I_x$	$S_x$	$r_x$	$I_y$	$S_y$	$r_y$	$e_y$
mm	mm	mm	mm	mm	kg/m <sup>3</sup>	cm <sup>2</sup>	cm <sup>2</sup>	cm <sup>4</sup>	cm <sup>3</sup>	cm	cm <sup>4</sup>	cm <sup>3</sup>	cm	cm
100	40	15	3	8	4.28	5.45	2.82	76.88	15.38	3.76	10.41	3.84	1.38	1.29
140	70	30	3	8	7.34	9.35	4.02	280.23	40.03	5.47	67.30	15.44	2.68	2.64
160	70	30	3	8	7.81	9.95	4.62	384.69	48.09	6.22	70.80	15.70	2.67	2.49
160	80	34	3	8	8.47	10.79	4.62	427.20	53.40	6.29	103.10	20.68	3.09	3.01
160	80	34	3.65	8	10.21	13.01	5.57	510.03	63.75	6.26	121.93	24.46	3.06	3.01
160	80	30	4	8	10.89	13.87	6.08	545.86	68.23	6.27	124.07	24.35	2.99	2.90
160	80	35	4	8	11.20	14.27	6.08	554.90	69.36	6.24	133.39	26.90	3.06	3.04
180	80	25	3.6	8	10.14	12.91	6.22	642.27	71.36	7.05	109.29	20.30	2.91	2.62
180	80	25	4	8	11.20	14.27	6.88	705.60	78.40	7.03	119.15	22.13	2.89	2.62
100	50	20	2	8	3.40	4.33	1.92	65.92	13.18	3.90	15.36	4.85	1.88	1.84
200	60	20	2	8	5.28	6.73	3.92	386.55	38.66	7.58	30.47	6.96	2.13	1.62
250	70	20	2	8	6.38	8.13	4.92	723.51	57.88	9.43	47.56	9.05	2.42	1.74
185	60	25	1.5	8	3.93	5.00	2.73	251.81	27.22	7.09	25.60	6.12	2.26	1.82
185	60	26.4	2	8	5.25	6.69	3.62	333.19	36.02	7.06	34.09	8.22	2.26	1.85
185	60	27.7	2.5	8	6.56	8.36	4.50	412.99	44.65	7.03	42.46	10.32	2.25	1.89
185	60	29.1	3	8	7.89	10.05	5.37	491.57	53.14	7.00	50.82	12.46	2.25	1.92
215	60	25	1.5	8	4.29	5.46	3.18	360.67	33.55	8.13	26.86	6.21	2.22	1.67
215	60	26.4	2	8	5.72	7.29	4.22	477.98	44.46	8.10	35.79	8.34	2.21	1.70
215	60	27.7	2.5	8	7.15	9.11	5.25	593.41	55.20	8.07	44.59	10.47	2.21	1.74
215	60	29.1	3	8	8.59	10.95	6.27	707.49	65.81	8.04	53.41	12.64	2.21	1.78

## STRAIGHT LIPPED Z-SECTION (COLD FORMED SECTION)

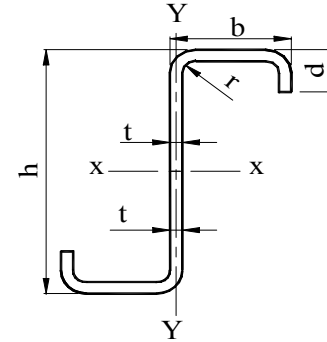

Dimensions					Weight	Area	$A_{web}$	Axis X-X			Axis Y-Y		
h	b	d	t	r				$I_x$	$S_x$	$r_x$	$I_y$	$S_y$	$r_y$
mm	mm	mm	mm	mm	kg/m`	cm <sup>2</sup>	cm <sup>2</sup>	cm <sup>4</sup>	cm <sup>3</sup>	cm	cm <sup>4</sup>	cm <sup>3</sup>	cm
100	50	20	2	8	3.40	4.33	1.92	65.92	13.18	3.90	28.40	5.80	2.56
150	60	20	2	8	4.50	5.73	2.92	195.22	26.03	5.84	46.04	7.80	2.83
150	60	20	2.5	8	5.58	7.10	3.63	239.74	31.97	5.81	55.66	9.47	2.80
200	60	20	2	8	5.28	6.73	3.92	386.55	38.65	7.58	46.04	7.80	2.62
200	60	20	2.5	8	6.56	8.35	4.88	475.94	47.59	7.55	55.66	9.47	2.58
250	70	20	2	8	6.38	8.13	4.92	723.51	57.88	9.43	69.53	10.08	2.92
250	70	20	2.5	8	7.93	10.10	6.13	893.12	71.45	9.40	84.41	12.28	2.89

## INCLINED LIPPED Z-SECTION (COLD FORMED SECTION)

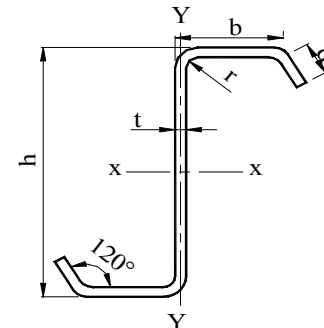

Dimensions					Weight	Area	$A_{web}$	Axis X-X			Axis Y-Y		
h	b	d	t	r				$I_x$	$S_x$	$r_x$	$I_y$	$S_y$	$r_y$
mm	mm	mm	mm	mm	kg/m`	cm <sup>2</sup>	cm <sup>2</sup>	cm <sup>4</sup>	cm <sup>3</sup>	cm	cm <sup>4</sup>	cm <sup>3</sup>	cm
185	60	20.8	1.5	8	3.83	4.88	2.73	246.10	26.60	7.10	37.66	6.36	2.78
185	60	21.8	2	8	5.10	6.50	3.62	325.13	35.15	7.07	50.12	8.50	2.78
185	60	22.8	2.5	8	6.37	8.12	4.50	402.66	43.53	7.04	62.53	10.64	2.78
185	60	23.8	3	8	7.64	9.73	5.37	478.65	51.75	7.01	74.88	12.80	2.77
215	60	20.8	1.5	8	4.19	5.33	3.18	352.12	32.76	8.13	37.66	6.36	2.66
215	60	21.8	2	8	5.58	7.10	4.22	465.85	43.33	8.10	50.12	8.50	2.66
215	60	22.8	2.5	8	6.96	8.87	5.25	577.73	53.74	8.07	62.53	10.64	2.66
215	60	23.8	3	8	8.34	10.63	6.27	687.74	63.98	8.04	74.88	12.80	2.65

# COMBINED COLD FORMED SECTIONS

TWO CHANNELS BACK TO BACK

TWO CHANNELS TOE TO TOE

# TWO CHANNELS (Cold Formed) BACK to BACK

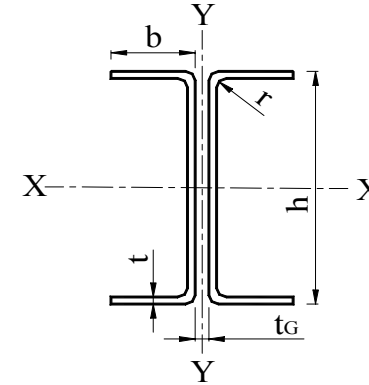

Dimensions				Weight	Area	A <sub>web</sub>	Axis X-X			Axis Y-Y								
h	b	t	r				kg/m	cm <sup>2</sup>	cm <sup>2</sup>	I <sub>x</sub>	S <sub>x</sub>	r <sub>x</sub>	I <sub>y</sub>	S <sub>y</sub>	r <sub>y</sub>	I <sub>y</sub>	S <sub>y</sub>	r <sub>y</sub>
							cm <sup>4</sup>	cm <sup>3</sup>	cm	t <sub>G</sub> = 8 mm			t <sub>G</sub> = 10 mm			t <sub>G</sub> = 12 mm		
30	25	4	8	3.98	5.08	1.76	5.74	3.82	1.06	13.39	4.62	1.62	14.92	4.97	1.71	16.56	5.34	1.81
40	20	4	8	3.98	5.08	2.56	9.60	4.80	1.38	7.95	3.31	1.25	9.15	3.66	1.34	10.45	4.02	1.43
40	24	4	8	4.48	5.72	2.56	11.68	5.84	1.43	12.37	4.42	1.47	13.91	4.80	1.56	15.57	5.19	1.65
50	25	4	8	5.24	6.68	3.36	21.60	8.64	1.80	13.90	4.79	1.44	15.63	5.21	1.53	17.50	5.65	1.62
50	35	4	8	6.50	8.40	3.36	30.06	12.02	1.91	32.99	8.46	1.98	35.88	8.97	2.07	38.93	9.50	2.15
60	30	4	8	6.48	8.28	4.16	40.60	13.54	2.22	22.12	6.51	1.63	24.47	6.99	1.72	26.99	7.50	1.81
65	38	4	8	7.80	9.96	4.56	61.42	18.90	2.48	40.76	9.70	2.02	44.14	10.27	2.11	47.73	10.85	2.19
70	25	4	8	6.50	8.28	4.96	50.80	14.52	2.48	14.57	5.03	1.33	16.53	5.51	1.41	18.65	6.01	1.50
80	45	4	8	9.62	12.28	5.76	117.62	29.40	3.10	64.33	13.13	2.29	68.90	13.78	2.37	73.71	14.45	2.45
100	50	4	8	11.52	14.68	7.36	218.80	43.76	3.86	86.13	15.95	2.42	91.73	16.68	2.50	97.64	17.44	2.58
120	60	4	8	14.02	17.88	8.96	391.60	65.26	4.68	142.60	22.28	2.82	150.33	23.13	2.90	158.41	24.00	2.98
140	65	4	8	15.92	20.28	10.56	600.26	85.76	5.44	178.58	25.88	2.97	187.58	26.80	3.04	196.99	27.75	3.12
160	65	4	8	17.16	21.88	12.16	822.56	102.82	6.13	178.69	25.90	2.86	187.88	26.84	2.93	197.51	27.82	3.00
180	80	4	8	20.12	25.88	13.76	1274.5	141.60	7.02	321.36	38.26	3.52	334.51	39.35	3.60	348.17	40.48	3.67
200	80	4	8	21.56	27.48	15.36	1632.1	163.20	7.71	321.92	38.32	3.42	335.27	39.44	3.49	349.18	40.60	3.56
200	100	4	8	24.08	30.68	15.36	1939.4	193.94	7.95	605.48	58.22	4.44	624.87	59.51	4.51	644.87	60.84	4.58

## TWO CHANNELS BACK to BACK (Cold Formed SECTION)

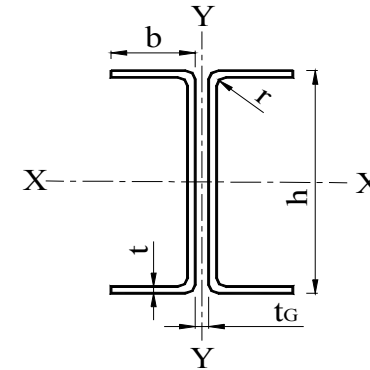

Dimensions				Weight	Area	A <sub>web</sub>	Axis X-X			Axis Y-Y								
							I <sub>x</sub>	S <sub>x</sub>	r <sub>x</sub>	I <sub>y</sub>	S <sub>y</sub>	r <sub>y</sub>	I <sub>y</sub>	S <sub>y</sub>	r <sub>y</sub>	I <sub>y</sub>	S <sub>y</sub>	r <sub>y</sub>
h	b	t	r	kg/m`	cm <sup>2</sup>	cm <sup>2</sup>	cm <sup>4</sup>	cm <sup>3</sup>	cm	t <sub>G</sub> = 8 mm			t <sub>G</sub> = 10 mm			t <sub>G</sub> = 12 mm		
60	40	3.6	8	7.02	8.96	4.22	48.96	16.32	2.34	41.79	9.50	2.16	45.04	10.01	2.24	48.46	10.53	2.33
60	40	4	8	7.74	9.88	4.16	53.16	17.72	2.32	46.58	10.59	2.17	50.20	11.16	2.25	54.01	11.74	2.34
80	40	2.25	8	5.22	6.64	6.04	64.66	16.16	3.12	26.23	5.96	1.99	28.34	6.30	2.07	30.58	6.65	2.15
80	40	2.5	8	5.78	7.36	6.00	71.04	17.76	3.11	29.18	6.63	1.99	31.54	7.01	2.07	34.04	7.40	2.15
80	40	3	8	6.86	8.74	5.92	83.32	20.84	3.09	35.32	8.03	2.01	38.17	8.48	2.09	41.19	8.95	2.17
80	40	4	8	9.00	11.48	5.76	106.08	26.52	3.04	47.33	10.76	2.03	51.16	11.37	2.11	55.23	12.01	2.19
80	50	5	8	12.64	16.10	5.60	154.60	38.66	3.10	107.42	19.89	2.58	114.22	20.77	2.66	121.33	21.67	2.75
100	40	3	8	7.82	9.94	7.52	141.92	28.38	3.78	35.52	8.07	1.89	38.50	8.56	1.97	41.68	9.06	2.05
100	40	4	8	10.26	13.08	7.36	181.94	36.38	3.73	47.70	10.84	1.91	51.73	11.50	1.99	56.02	12.18	2.07
100	50	5	8	14.20	18.10	7.20	263.66	52.74	3.82	108.67	20.12	2.45	115.77	21.05	2.53	123.22	22.00	2.61
120	60	4	8	14.02	17.88	8.96	391.60	65.26	4.68	142.60	22.28	2.82	150.33	23.13	2.90	158.41	24.00	2.98
140	63	4	8	15.66	19.96	10.56	585.46	83.64	5.42	164.12	24.50	2.87	172.71	25.40	2.94	181.69	26.33	3.02
160	63	4	8	16.92	21.56	12.16	803.08	100.38	6.10	164.78	24.59	2.76	173.58	25.53	2.84	182.80	26.49	2.91
180	75	4	8	19.68	25.08	13.76	1212.5	134.72	6.95	267.07	33.81	3.26	278.86	34.86	3.33	291.15	35.94	3.41

## TWO CHANNELS TOE to TOE (COLD FORMED SECTION)

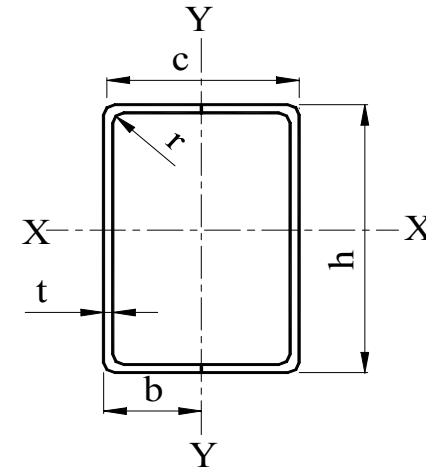

Dimensions (mm)				Weight	Area	$A_{web}$	Axis x-x			Axis y-y (toe to toe)			Axis y-y (c=h)		
h	b	t	r				$I_x$	$S_x$	$r_x$	$I_y$	$S_y$	$r_y$	$I_y$	$S_y$	$r_y$
kg/m <sup>1</sup>	cm <sup>2</sup>	cm <sup>2</sup>	cm <sup>4</sup>	cm <sup>3</sup>	cm	cm <sup>4</sup>	cm <sup>3</sup>	cm	cm <sup>4</sup>	cm <sup>3</sup>	cm	cm <sup>4</sup>	cm <sup>3</sup>	cm	
30	25	4	8	3.99	5.08	1.76	5.74	3.82	1.06	13.09	5.24	1.61	N.A.		
40	20	4	8	3.99	5.08	2.56	9.60	4.80	1.38	9.65	4.83	1.38	9.65	4.83	1.38
40	24	4	8	4.49	5.72	2.56	11.68	5.84	1.43	15.57	6.49	1.65	N.A.		
50	25	4	8	5.24	6.68	3.36	21.60	8.64	1.80	21.65	8.66	1.80	21.65	8.66	1.80
50	35	4	8	6.59	8.40	3.36	30.06	12.02	1.91	51.33	14.67	2.47	N.A.		
60	30	4	8	6.50	8.28	4.16	40.60	13.54	2.22	40.70	13.57	2.22	40.70	13.57	2.22
65	38	4	8	7.82	9.96	4.56	61.42	18.90	2.48	78.40	20.63	2.81	N.A.		
70	25	4	8	6.50	8.28	4.96	50.80	14.52	2.48	29.94	11.98	1.90	67.53	19.29	2.86
80	45	4	8	9.64	12.28	5.76	117.62	29.40	3.10	141.35	31.41	3.39	106.48	26.62	2.94
100	50	4	8	11.52	14.68	7.36	218.80	43.76	3.86	219.30	43.86	3.87	219.30	43.86	3.87
120	60	4	8	14.04	17.88	8.96	391.60	65.26	4.68	392.07	65.34	4.68	392.07	65.34	4.68
140	65	4	8	15.92	20.28	10.56	600.26	85.76	5.44	536.80	82.58	5.14	637.80	91.11	5.61
160	65	4	8	17.18	21.88	12.16	822.56	102.82	6.13	601.41	92.52	5.24	969.00	121.12	6.65
180	80	4	8	20.32	25.88	13.76	1274.46	141.60	7.02	1064.84	133.10	6.41	1396.62	155.18	7.35
200	80	4	8	21.57	27.48	15.36	1632.08	163.20	7.71	1162.15	145.27	6.50	1933.78	193.38	8.39
200	100	4	8	24.08	30.68	15.36	1939.40	193.94	7.95	1939.20	193.92	7.95	1939.20	193.92	7.95

N.A.= Section is not available with the specified configuration.

## TWO CHANNELS (Cold Formed) TOE to TOE

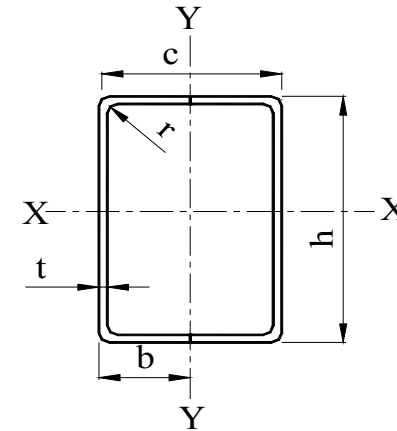

Dimensions (mm)				Weight kg/m`	Area cm <sup>2</sup>	A <sub>web</sub> cm <sup>2</sup>	Axis x-x			Axis y-y (toe to toe)			Axis y-y (c=h)		
h	b	t	r				I <sub>x</sub> cm <sup>4</sup>	S <sub>x</sub> cm <sup>3</sup>	r <sub>x</sub> cm	I <sub>y</sub> cm <sup>4</sup>	S <sub>y</sub> cm <sup>3</sup>	r <sub>y</sub> cm	I <sub>y</sub> cm <sup>4</sup>	S <sub>y</sub> cm <sup>3</sup>	r <sub>y</sub> cm
60	40	3.6	8	7.03	8.96	4.22	48.96	16.32	2.34	76.49	19.12	2.92	N.A.		
60	40	4	8	7.76	9.88	4.16	53.16	17.72	2.32	83.10	20.78	2.90	N.A.		
80	40	2.25	8	5.21	6.64	6.04	64.66	16.16	3.12	64.79	16.20	3.12	64.79	16.20	3.12
80	40	2.5	8	5.78	7.36	6.00	71.04	17.76	3.11	71.28	17.82	3.11	71.28	17.82	3.11
80	40	3	8	6.86	8.74	5.92	83.32	20.84	3.09	83.00	20.75	3.08	83.00	20.75	3.08
80	40	4	8	9.01	11.48	5.76	106.08	26.52	3.04	105.92	26.48	3.04	105.92	26.48	3.04
80	50	5	8	12.64	16.10	5.60	154.60	38.66	3.10	218.71	43.74	3.69	N.A.		
100	40	3	8	7.80	9.94	7.52	141.92	28.38	3.78	101.12	25.28	3.19	169.71	33.94	4.13
100	40	4	8	10.27	13.08	7.36	181.94	36.38	3.73	129.42	32.36	3.15	218.63	43.73	4.09
100	50	5	8	14.21	18.10	7.20	263.66	52.74	3.82	263.10	52.62	3.81	263.10	52.62	3.81
120	60	4	8	14.04	17.88	8.96	391.60	65.26	4.68	392.07	65.34	4.68	392.07	65.34	4.68
140	63	4	8	15.67	19.96	10.56	585.46	83.64	5.42	498.45	79.12	5.00	636.78	90.97	5.65
160	63	4	8	16.92	21.56	12.16	803.08	100.38	6.10	557.69	88.52	5.09	965.26	120.66	6.69
180	75	4	8	19.69	25.08	13.76	1212.50	134.72	6.95	920.91	122.79	6.06	1398.68	155.41	7.47

N.A.= Section is not available with the specified configuration.



# BOLTS

ORDINARY BOLTS

HIGH STRENGTH BOLTS

ANCHOR BOLTS

# ORDINARY BOLTS

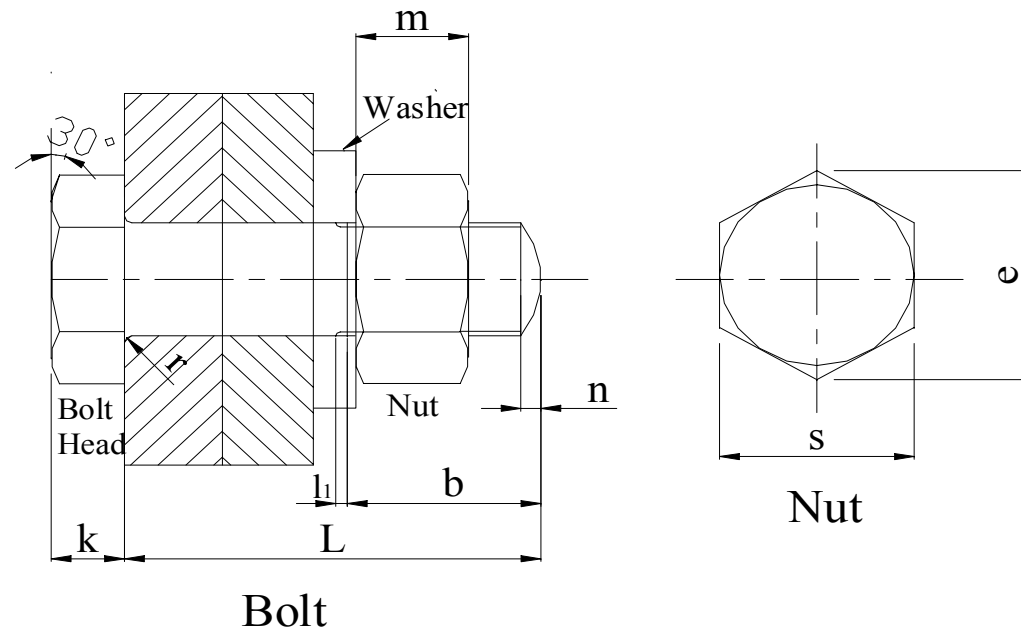

Nominal Bolt Size			M10	M12	M16	M20	M24	M27	M30
Bolt Dimensions	k	mm	7.0	8.0	10.0	13.0	15.0	17.0	19.0
	$l_1$	mm	1.9	2.5	3.0	4.0	4.5	4.5	5.0
	b	mm	26.0	19.5	23.0	26.0	29.5	32.5	35.0
	n	mm	2.2	2.5	3.0	3.5	4.5	4.5	5.0
	r	mm	0.5	0.6	0.6	0.8	0.8	1.0	1.0
	s	mm	17.0	19.0	24.0	30.0	36.0	41.0	46.0
	$e_{min.}$	mm	18.7	20.9	26.2	32.9	39.6	45.2	50.8
Nut Dimensions	m	mm	8.0	10.0	13.0	16.0	19.0	22.0	24.0
	s	mm	17.0	19.0	24.0	30.0	36.0	41.0	46.0
	$e_{min.}$	mm	18.7	20.9	26.2	39.5	39.6	45.2	50.8
Hole Diameter	$d_1$	mm	12.0	14.0	18.0	22.0	26.0	30.0	33.0

## MINIMUM AND MAXIMUM GRIPS FOR ORDINARY BOLTS, IN MILLIMETERS

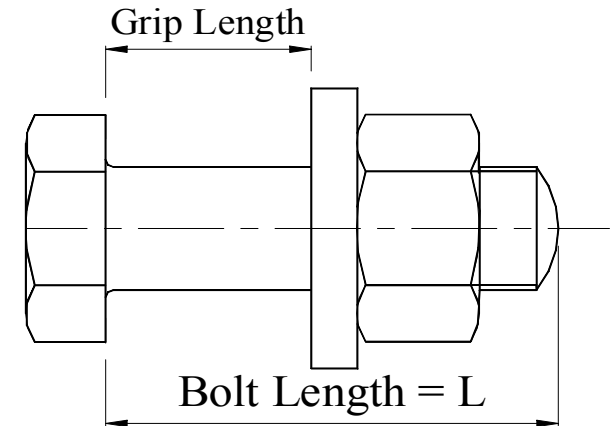

Nominal Bolt Size	M10		M12		M16		M20		M24		M27		M30	
	Min.Grip	Max. Grip	Min.Grip	Max. Grip	Min.Grip	Max. Grip	Min.Grip	Max. Grip	Min.Grip	Max. Grip	Min.Grip	Max. Grip	Min.Grip	Max. Grip
30	0	9	2	9										
35			10	11	6	7								
40	10	19	12	19	8	15	5	12	2	9				
45			20	21	16	17	13	14	10	11	7	8		
50	20	29	22	29	18	25	15	22	12	19	9	16	6	13
55			30	31	26	27	23	24	20	21	17	18	14	15
60	30	39	32	39	28	35	25	32	22	29	19	26	16	23
65			40	41	36	37	33	34	30	31	27	28	24	25
70	40	49	42	49	38	45	35	42	32	39	29	36	26	33
75			50	51	46	47	43	44	40	41	37	38	34	35
80	50	59	52	59	48	55	45	52	42	49	39	46	36	43
85			60	61	56	57	53	54	50	51	47	48	44	45
90			62	69	58	65	55	62	52	59	49	56	46	53

# WASHERS FOR ORDINARY BOLTS

## Plain Circular Washer

Nominal Bolt Size		M10	M12	M16	M20	M24	M27	M30
$d_2$	mm	11	14	18	22	26	30	33
D	mm	21	24	30	37	44	50	56
$S_1$	mm	8	8	8	8	8	8	8

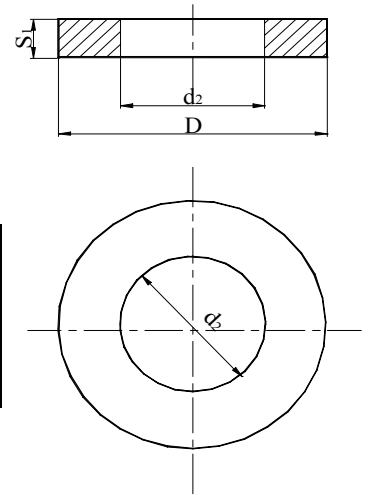

## Bevelled Square Washers For Channel Sections

Nominal Bolt Size		M10	M12	M16	M20	M24	M27
$d_2$	mm	11	14	18	22	26	30
b	mm	22	30	36	44	56	56
c	mm	2	2.5	3	3.5	4	4
e	mm	3.8	4.9	5.9	7	8.5	8.5
f	mm	2.9	3.7	4.45	5.25	6.25	6.25

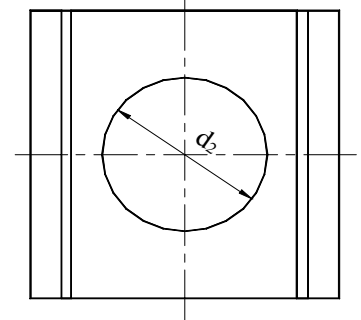
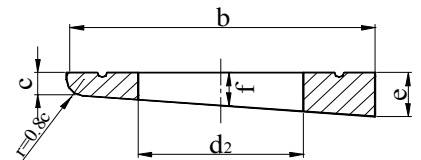

## Bevelled Square Washers For IPN Sections

Nominal Bolt Size		M10	M12	M16	M20	M24	M27
$d_2$	mm	11	14	18	22	26	30
b	mm	22	30	36	44	56	56
c	mm	1.5	2	2.5	3	3	3
e	mm	4.6	6.2	7.5	9.2	10.8	10.8
f	mm	3	4.1	5	6.1	6.9	6.9

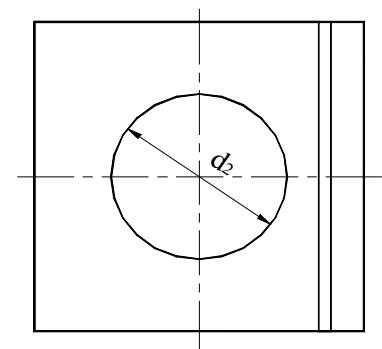
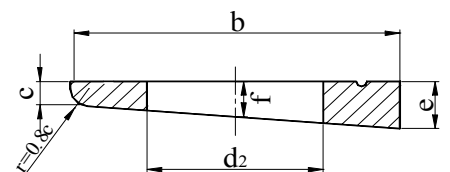

# LARGE DIAMETER ORDINARY BOLTS

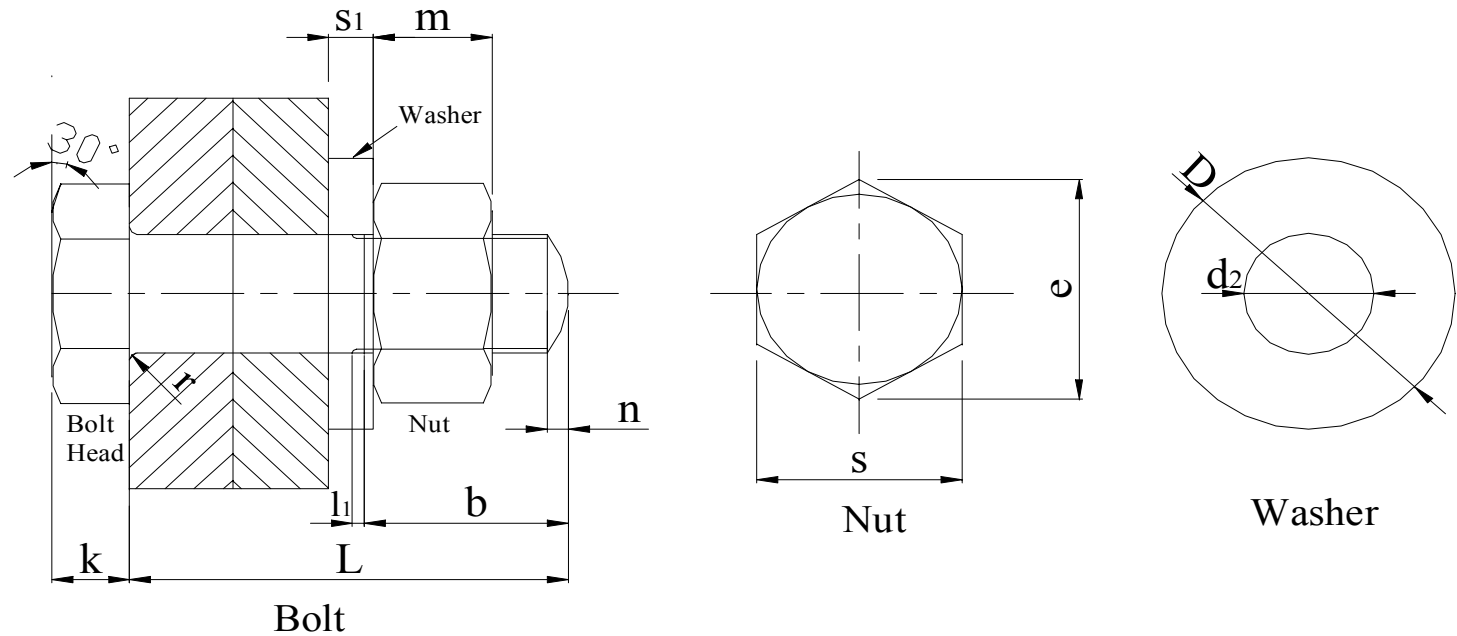

Nominal Bolt Size			M30	M33	M36	M39	M42	M45	M48	M52
Bolt Dimensions	k	mm	19	21	23	25	26	28	30	33
	$l_1$	mm	30	33	36	39	42	45	48	52
	b	mm	4.5	4.5	5	5	5.5	5.5	6.3	6.3
	n	mm	66	72	78	84	90	96	102	116
	r	mm	5	5	6	6	6.5	6.5	7.5	7.5
	s	mm	46	50	55	60	65	70	75	80
	$e_{min.}$	mm	50.8	55.4	60.8	66.4	72.1	77.7	83.4	89
Nut Dimensions	m	mm	24	26	29	31	34	36	38	42
	s	mm	46	50	55	60	65	70	75	80
	$e_{min.}$	mm	50.8	55.4	60.8	66.4	72.1	77.7	83.4	89
Washer Dimensions	D	mm	56	60	66	N.A.				
	d2	mm	33	36	39					
	s1	mm	8	8	8					
Hole Diameter	$d_1$	mm	33	36	39	42	45	48	51	55

N.A. = Washer plates with appropriate thickness are used with these bolts size

# HIGH STRENGTH BOLTS

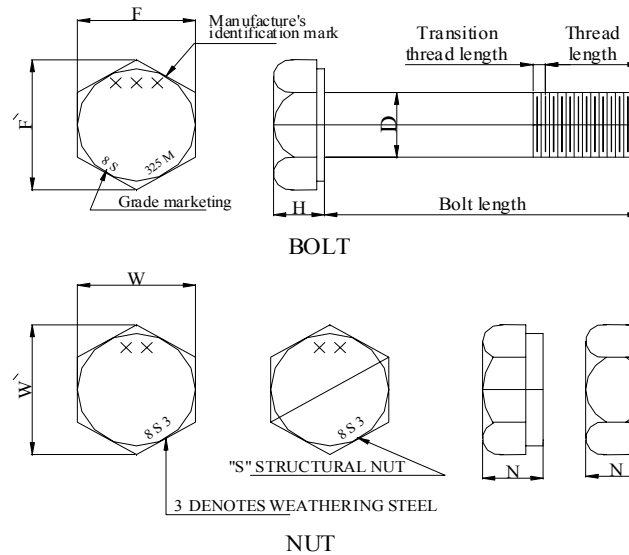

## DIMENSIONS

Nominal Bolt Size	Heavy Hex Bolt or Nut Dimension				Heavy Hex Nut Max. Height N	Heavy Hex Structural Bolt			
	Across Flats F or W		Across Corners F' or W'			Max. Head Height H	Thread Length		Max. Transition Thread Length
	Max.	Min.	Max.	Min.			Bolt Lengths ≤100	Bolt Lengths >100	
mm	mm	mm	mm	mm	mm	mm	mm	mm	
<b>M16</b>	27	26.2	31.18	29.56	17.1	10.75	31	38	6.0
<b>M20</b>	34	33.0	39.26	37.29	20.7	13.40	36	43	7.5
<b>M22</b>	36	35.0	41.57	39.55	23.6	14.90	38	45	7.5
<b>M24</b>	41	40.0	47.34	45.20	24.2	15.90	41	48	9.0
<b>M27</b>	46	45.0	53.12	50.58	27.6	17.90	44	51	9.0
<b>M30</b>	50	49.0	57.74	55.37	30.7	19.75	49	56	10.5
<b>M36</b>	60	58.8	69.28	66.44	36.6	23.55	56	63	12.0

## MINIMUM AND MAXIMUM GRIPS FOR HIGH STRENGTH BOLTS IN MILLIMETERS

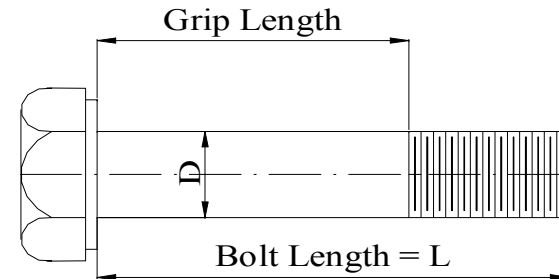

Nominal Bolt Size	M16		M20		M22		M24		M27		M30		M36	
	Min. Grip	Max. Grip	Min. Grip	Max. Grip	Min. Grip	Max. Grip	Min. Grip	Max. Grip	Min. Grip	Max. Grip	Min. Grip	Max. Grip	Min. Grip	Max. Grip
L Bolt Length (mm)														
45	14	26		23		20								
50	19	31	14	28		25		24						
55	24	36	19	32	17	29		29		25				
60	29	41	24	37	22	34	19	34		30		27		
65	34	46	29	42	27	39	24	39	21	35		32		
70	39	51	34	47	32	44	29	44	26	40	21	37		31
75	44	56	39	52	37	49	34	49	31	45	26	42		36
80	49	61	44	57	42	59	39	54	36	50	31	47	24	41
85	54	66	49	62	47	59	44	59	41	55	36	52	29	46
90	59	71	54	67	52	64	49	64	46	60	41	57	34	51
95	64	76	59	72	57	69	54	69	51	65	46	62	39	56
100	69	81	64	77	62	74	59	74	56	70	51	67	44	61
110	72	91	67	87	65	84	62	84	59	80	54	77	47	71
120	82	101	77	97	75	94	72	94	69	90	64	87	57	81
130	92	110	87	107	85	104	82	103	79	100	74	97	67	91
140	102	120	97	117	95	114	92	113	89	110	84	107	77	101
150	112	130	107	127	105	124	102	123	99	120	94	117	87	111

## MINIMUM AND MAXIMUM GRIPS FOR HIGH STRENGTH BOLTS IN MILLIMETERS

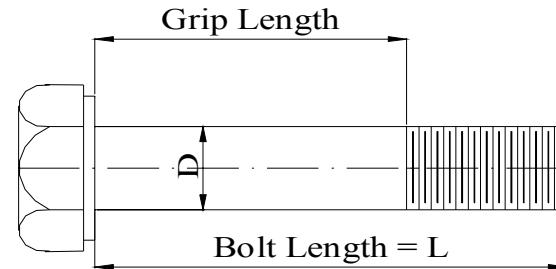

Nominal Bolt Size L Bolt Length (mm)	M16		M20		M22		M24		M27		M30		M36	
	Min. Grip	Max. Grip	Min. Grip	Max. Grip	Min. Grip	Max. Grip	Min. Grip	Max. Grip	Min. Grip	Max. Grip	Min. Grip	Max. Grip	Min. Grip	Max. Grip
160	122	138	117	135	115	132	112	131	109	128	104	125	97	119
170	132	148	127	145	125	142	122	141	119	138	114	135	107	129
180	142	158	137	155	135	152	132	151	129	148	124	145	117	139
190	152	168	147	165	145	162	142	161	139	158	134	155	127	149
200	162	178	157	175	155	172	152	171	149	168	144	165	137	159
210	172	188	167	185	165	182	162	181	159	178	154	175	147	169
220	182	198	177	195	175	192	172	191	169	188	164	185	157	179
230	192	208	187	205	185	202	182	201	179	198	174	195	167	189
240	202	218	197	215	195	212	192	211	189	208	184	205	177	199
250	212	228	207	225	205	222	202	221	199	218	194	215	187	209
260	222	238	217	235	215	232	212	231	209	228	204	225	197	219
270	232	248	227	245	225	242	222	241	219	238	214	235	207	229
280	242	258	237	255	235	252	232	251	229	248	224	245	217	239
290	252	268	247	265	245	262	242	261	239	258	234	255	227	249
300	262	278	257	275	255	272	252	271	249	268	244	265	237	259



# WASHERS FOR HIGH STRENGTH BOLTS

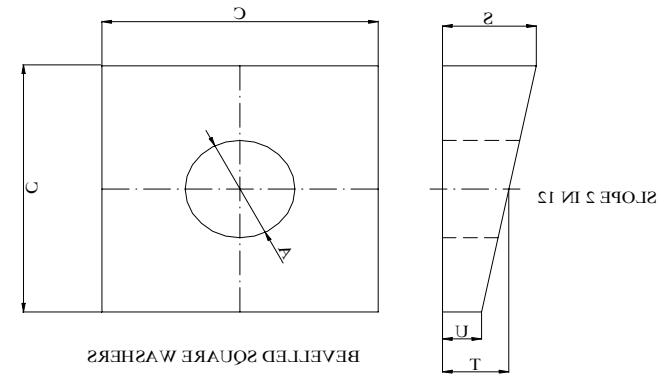
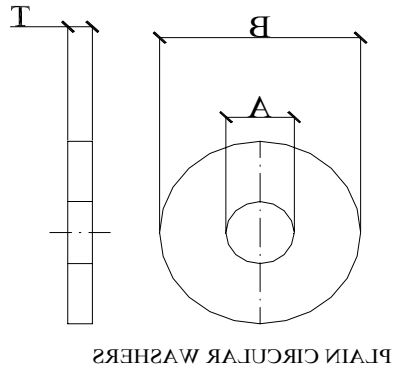

Metric Bolt Size	Outside Diameter		Hole Diameter		Thickness	
	B (mm)		A (mm)		T (mm)	
	Max.	Min.	Max.	Min.	Max.	Min.
M16	34	32.4	18.4	18	4.6	3.1
M20	41	39.4	22.5	22	4.6	3.1
M22	44	42.4	24.5	24	4.6	3.4
M24	50	48.4	26.5	26	4.6	3.4
M27	56	54.1	30.5	30	4.6	3.4
M30	60	58.1	33.5	33	4.6	3.4
M36	72	70.1	39.5	39	4.6	3.4

Metric Bolt Size	Width		Hole Diameter		Thickness		
	C (mm)		A (mm)		S (mm)	T (mm)	U (mm)
	Max.	Min.	Max.	Min.	±0.5		±0.5
M16	45	43	18.4	18	11.7	8	4.3
M20	45	43	22.5	22	11.7	8	4.3
M22	45	43	24.5	24	11.7	8	4.3
M24	45	43	26.5	26	11.7	8	4.3
M27	59	57	30.5	30	12.8	8	3.2
M30	59	57	33.5	33	12.8	8	3.2
M36	59	57	39.5	39	12.8	8	3.2

# ERECTION CLEARANCES FOR IMPACT WRENCHES

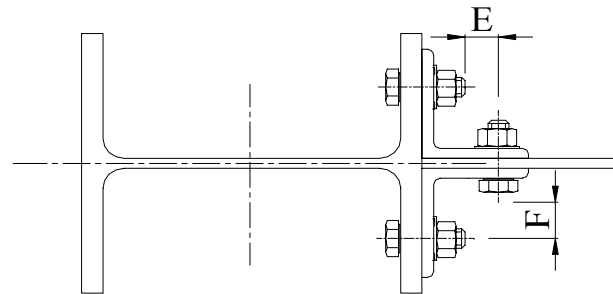
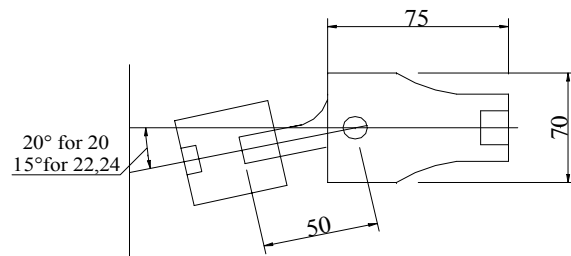
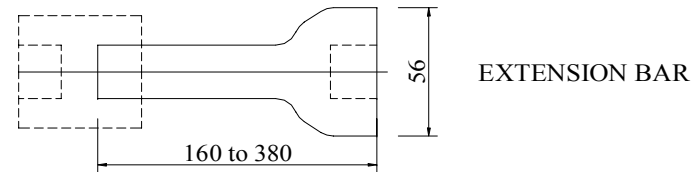
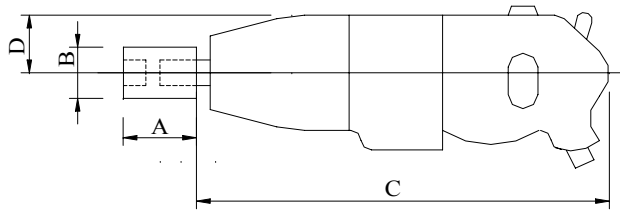

Minimum Clearances

	Size	C	D
Light Wrenches	16-24	377-356	54
Heavy Wrenches	24-36	375-438	64

Bolt Size	Sockets		Min. Clearance	
	A	B	E	F
16	80	45	25	28
20	85	54	30	34
22	90	57	32	36
24	95	60	34	38
27	100	70	38	42
30	110	75	41	45
36	130	90	48	52

# ANCHOR BOLTS

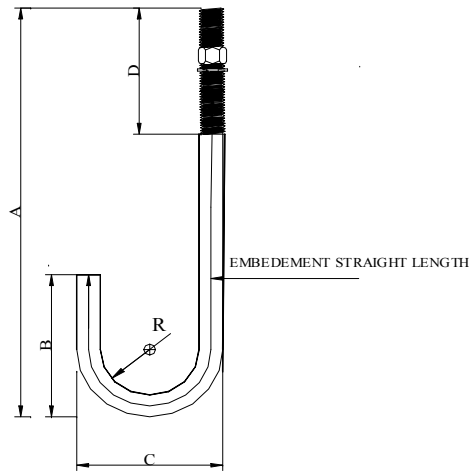

TYPICAL ANCHOR BOLT PROFILE

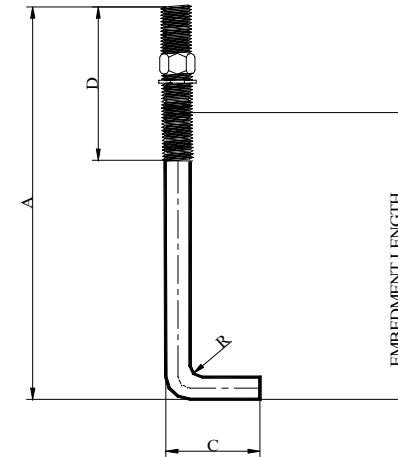

TYPICAL ANCHOR BOLT PROFILE

Bolt		Weight kg	A mm	B mm	C mm	D mm	R mm	Total Straight Length mm	Embedment Straight Length mm
Nominal Diameter	Thread Pitch								
M16	2.0	0.88	400	110	128	100	48	558	633
M20	2.5	1.72	500	140	160	125	60	700	775
M24	3.0	3.00	600	170	192	125	72	842	917
M30	3.5	7.00	900	240	300	150	120	1265	1340
M36	4.0	12.00	1000	400	360	200	144	1510	1635

Bolt		Weight kg	A mm	C mm	D mm	R mm	Total Straight Length mm	Embedment Straight Length mm
Nominal Bolt Size	Thread Pitch							
M20	2.5	1.48	380	160	90	60	600	330
M25	3.0	2.90	500	180	125	75	755	400
M25	3.0	3.30	600	180	125	75	855	540
M32	3.5	8.00	900	240	125	128	1272	840-780
M32	3.5	8.53	980	240	125	128	1352	890-840

# SAMPLE OF CORRUGATED SHEETS

SINGLE LAYER CORRUGATED SHEETS

SANDWITCH PANELS

METAL DECK PANELS

# SINGLE LAYER CORRUGATED STEEL SHEETS (St.52)

**800 mm MODULE**

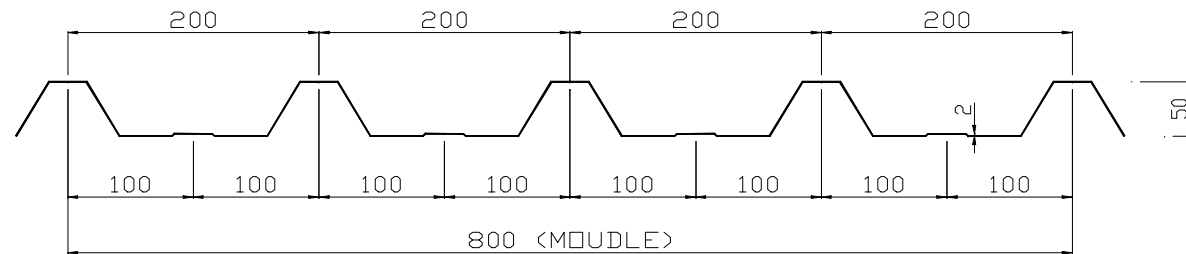

## Properties & Purlin Spacing

Panel Nominal Thickness	Nominal Weight	Nominal Area	$I_x$	$S_{xt}$	$S_{xb}$	Live Load ( $\text{kg/m}^2$ )			
						50	100	150	200
mm	$\text{kg/m}^2$	$\text{cm}^2$	$\text{cm}^4$	$\text{cm}^3$	$\text{cm}^3$	Allowable Purlin Spacing (cm)			
0.5	5.62	7.16	16.19	3.69	13.13	345	245	200	170
0.6	6.74	8.59	22.53	5.34	16.34	415	295	240	200
0.7	7.86	10.02	28.94	7.22	19.57	485	345	280	240

## SINGLE LAYER CORRUGATED STEEL SHEETS (St.52)

**900 mm MODULE**

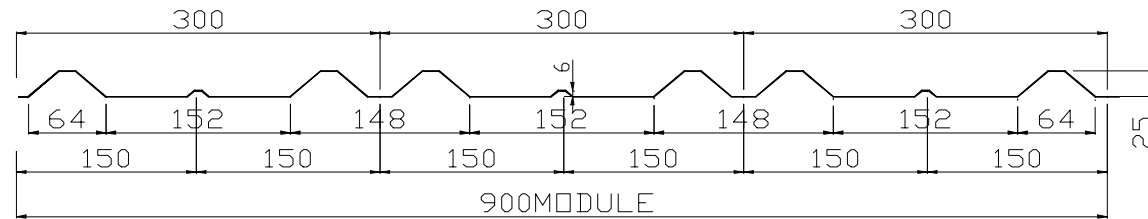

### Properties & Purlin Spacing

Panel Nominal Thickness	Nominal Weight	Nominal Area	$I_x$	$S_{xt}$	$S_{xb}$	Live Load ( $\text{kg/m}^2$ )			
						50	100	150	200
mm	$\text{kg/m}^2$	$\text{cm}^2$	$\text{cm}^4$	$\text{cm}^3$	$\text{cm}^3$	Allowable Purlin Spacing (cm)			
0.5	4.99	6.36	4.05	2.15	4.97	265	185	150	130
0.6	5.99	7.63	5.13	2.96	6.3	310	220	180	155
0.7	6.99	8.91	6.15	3.64	7.61	345	240	200	170

# SINGLE LAYER CORRUGATED STEEL SHEETS (St.52)

**960 mm MODULE**

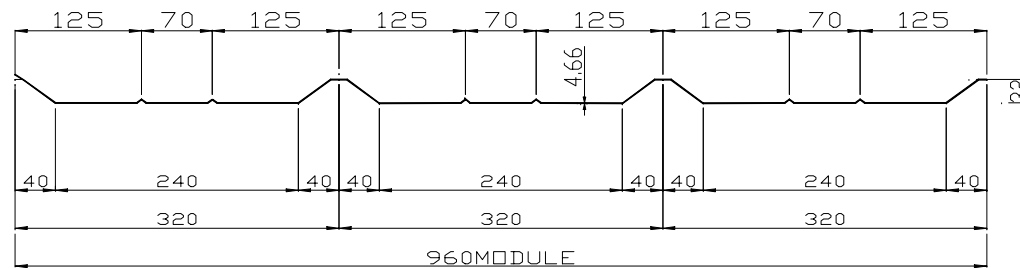

## Properties & Purlin Spacing

Panel Nominal Thickness	Nominal Weight	Nominal Area	$I_x$	$S_{xt}$	$S_{xb}$	Live Load (kg/m <sup>2</sup> )			
						50	100	150	200
mm	kg/m <sup>2</sup>	cm <sup>2</sup>	cm <sup>4</sup>	cm <sup>3</sup>	cm <sup>3</sup>	Allowable Purlin Spacing (cm)			
0.5	4.68	5.96	4.47	1.39	7.79	215	150	120	100
0.6	5.62	7.16	6.19	2.07	9.74	260	185	150	130
0.7	6.55	8.35	7.57	2.84	11.76	300	215	175	150

## SINGLE LAYER CORRUGATED STEEL SHEETS (St.52)

1000 mm MODULE

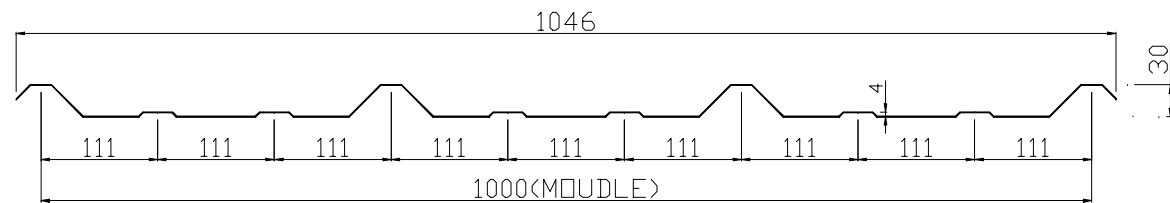

### Properties & Purlin Spacing

Panel Nominal Thickness	Nominal Weight	Nominal Area	$I_x$	$S_{xt}$	$S_{xb}$	Live Load (kg/m <sup>2</sup> )			
						50	100	150	200
mm	kg/m <sup>2</sup>	cm <sup>2</sup>	cm <sup>4</sup>	cm <sup>3</sup>	cm <sup>3</sup>	Allowable Purlin Spacing (cm)			
0.5	4.49	5.73	3.8	1.27	6.53	200	145	115	100
0.6	5.39	6.87	5.16	1.91	8.3	245	175	140	120
0.7	6.29	8.02	6.48	2.53	10.13	285	200	165	140



# SINGLE LAYER CORRUGATED STEEL SHEETS (St.52)

**1065 mm MODULE**

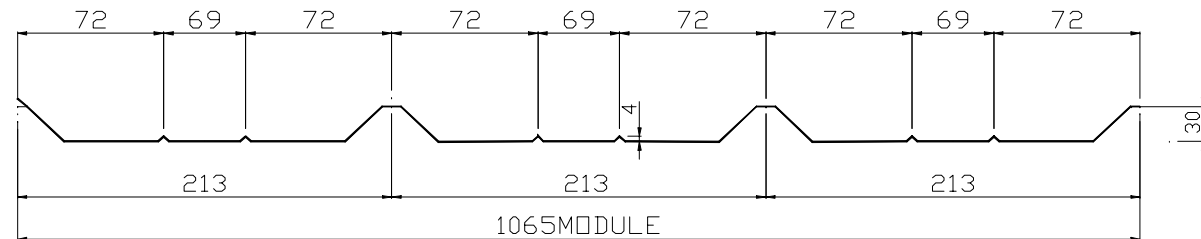

## Properties & Purlin Spacing

Panel Nominal Thickness	Nominal Weight	Nominal Area	$I_x$	$S_{xt}$	$S_{xb}$	Live Load (kg/m <sup>2</sup> )			
						50	100	150	200
mm	kg/m <sup>2</sup>	cm <sup>2</sup>	cm <sup>4</sup>	cm <sup>3</sup>	cm <sup>3</sup>	Allowable Purlin Spacing (cm)			
0.5	4.71	6	4.86	1.82	6.91	245	170	140	120
0.6	5.65	7.2	6.45	2.59	8.66	290	205	165	140
0.7	6.59	8.39	7.75	3.38	10.35	330	235	190	160

# SINGLE LAYER CORRUGATED STEEL SHEETS

**1065 mm MODULE**

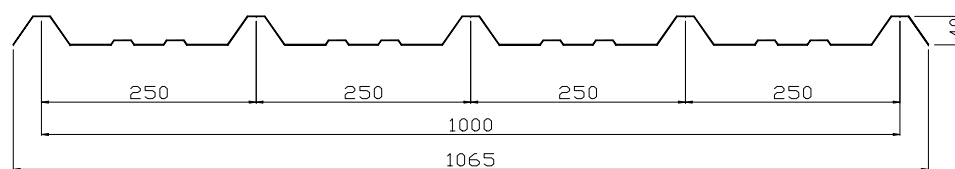

## Properties & Purlin Spacing

Panel Nominal Thicknes mm	Nominal Weight kg/m <sup>2</sup>	I <sub>x</sub> cm <sup>4</sup>	Live Load (kg/m <sup>2</sup> )			
			50	100	150	200
			Allowable Purlin Spacing (cm)			
0.50	4.75	12.53	240	170	140	125
0.55	5.23	13.79	250	180	150	130
0.60	5.70	15.04	260	190	155	135
0.65	6.18	16.29	270	195	160	140
0.70	6.66	17.51	275	205	170	145

# SANDWITCH ROOF PANELS

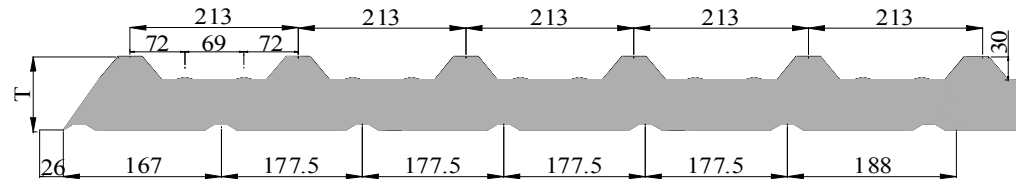

## Properties

Panel Nominal Thickness T (mm)	Weight (kg/m <sup>2</sup> )	I <sub>x</sub> (cm <sup>4</sup> )	S <sub>x</sub> (cm <sup>3</sup> )
65	9.48	50.4	12
80	10.08	64.4	18.6
105	11.08	191.2	31
130	12.08	289.9	44.2

## Allowable Uniform Loads (kg/m<sup>2</sup>)

Panel Nominal Thickness T (mm)	Span in Meters					
	2.5	3	3.5	4	4.5	5
65	164	137	117	103	91	75
80	224	187	160	140	125	112
105	324	271	232	203	180	162
130	425	354	303	266	236	212

# SANDWICH SIDE WALL PANELS

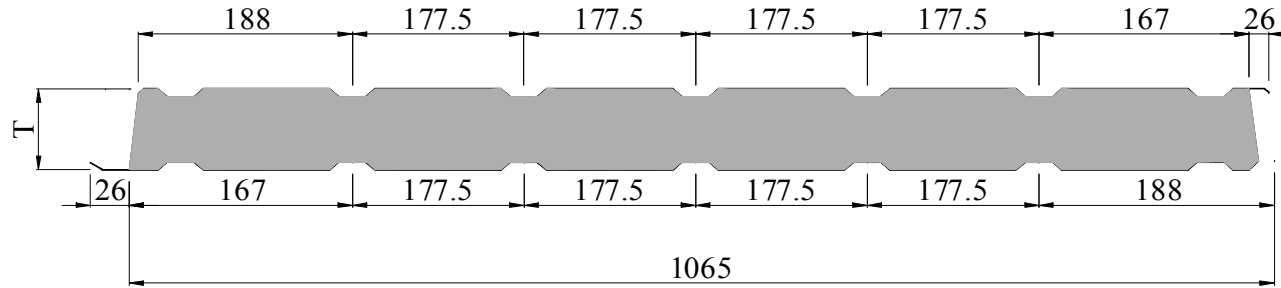

## Properties

Panel Nominal Thickness (mm)	Weight (kg/m <sup>2</sup> )	Ix (cm <sup>4</sup> )	Sx (cm <sup>3</sup> )
35	8.74	30.5	17.3
50	9.34	64.4	25.3
75	10.34	144.9	37.9
100	11.34	257.9	50.6

## Allowable Uniform Loads (kg/m<sup>2</sup>)

Panel Nominal Thickness (mm)	Span in Meters					
	2.5	3	3.5	4	4.5	5
35	140	117	100	88	76	62
50	200	167	143	125	110	90
75	301	251	215	188	166	135
100	401	334	286	251	222	180

# CORRUGATED STEEL DECKING SHEETS FOR CONCRETE FLOOR SLABS

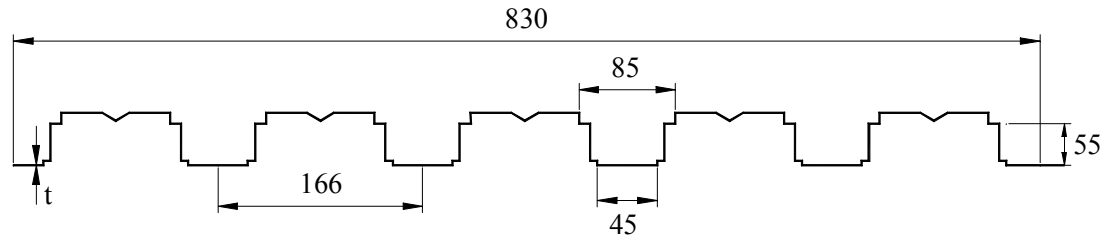

**PROFILE OF STEEL DECKING**

<b>EFFECTIVE CHARACTERISTICS OF THE STEEL DECKING SHEET</b>							
<b>Thickness t (mm)</b>		<b>0.70</b>	<b>0.75</b>	<b>0.80</b>	<b>0.88</b>	<b>1.00</b>	
<b>Weight (kg/m<sup>2</sup>)</b>		8.57	9.18	9.79	10.77	12.24	
<b>Moment of inertia (cm<sup>4</sup>)</b>		47.12	50.49	53.85	59.24	67.32	
<b>S<sub>xb</sub> (cm<sup>3</sup>)</b>		14.71	15.65	16.81	18.44	21.01	
<b>S<sub>xt</sub> (cm<sup>3</sup>)</b>		20.52	22.70	23.46	26.14	29.32	
<b>Weight (kg/m<sup>2</sup>)</b>	<b>Total thickness of the roof in (cm)</b>	<b>9.5</b>	156.6	157	157.6	158.4	159.6
		<b>10</b>	168.8	169.3	169.8	170.6	171.9
		<b>11</b>	193.3	193.8	194.3	195.1	196.4
		<b>12</b>	217.8	218.3	218.8	219.6	220.9
		<b>13</b>	242.3	242.8	243.3	244.1	245.4
		<b>14</b>	266.8	267.3	267.8	268.6	269.9
		<b>15</b>	291.3	291.8	292.3	293.1	294.4
<b>16</b>	315.8	316.3	316.8	317.6	318.8		

# ACCESSORIES

# ACCESSORIES\*

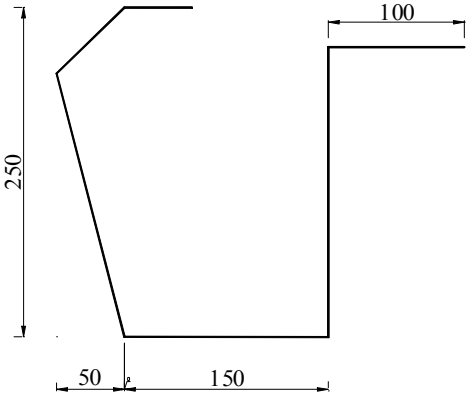

OUTSIDE GUTTER SECTION

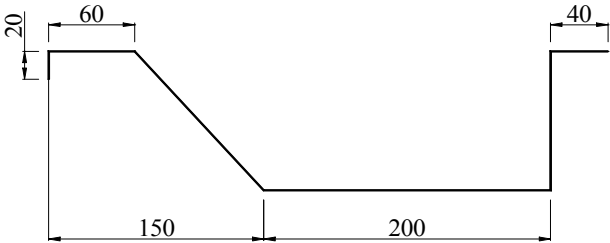

INSIDE GUTTER SECTION

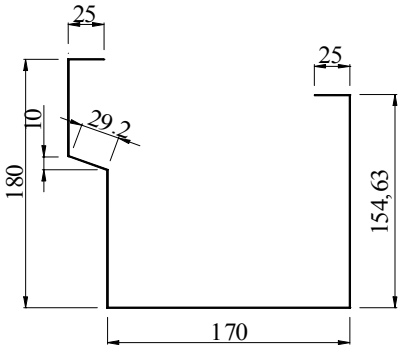

EAVE GUTTER

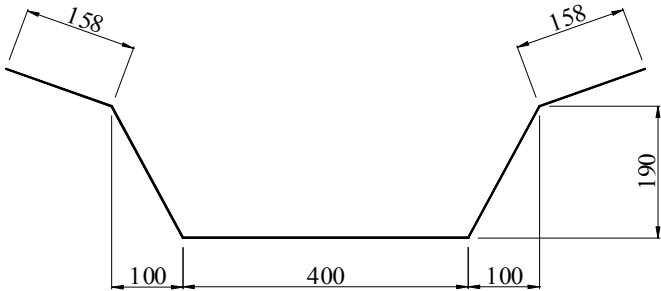

VALLEY GUTTER

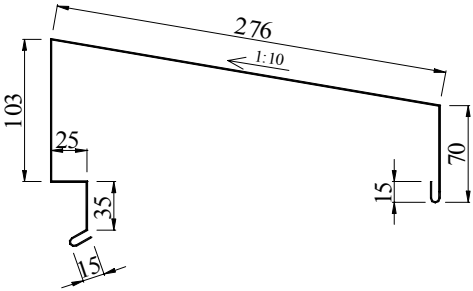

CAP FLASHING

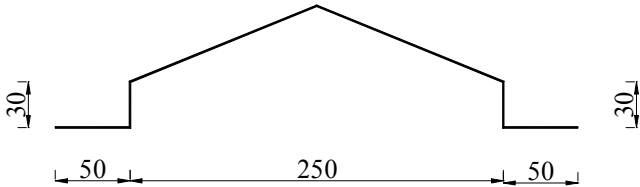

PEAK CAP SHEET

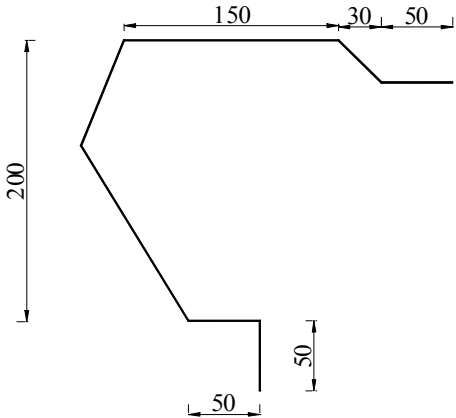

EAVE & PEAK FASCIA

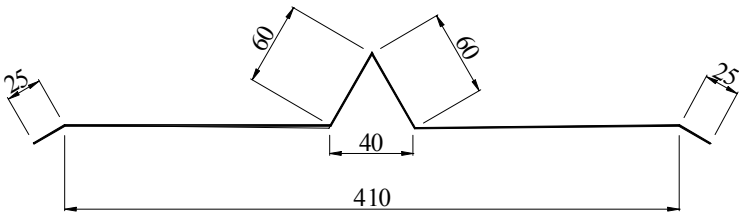

EXPANSION JOINT TRIM

\*Indicated dimensions may be altered to fit project requirements

# ACCESSORIES\*

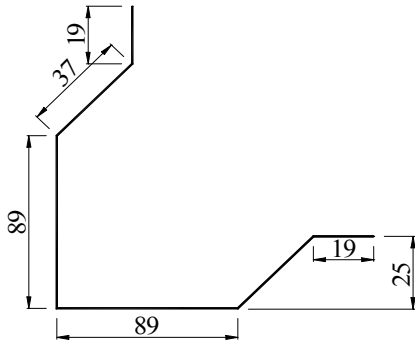

CORNER TRIM

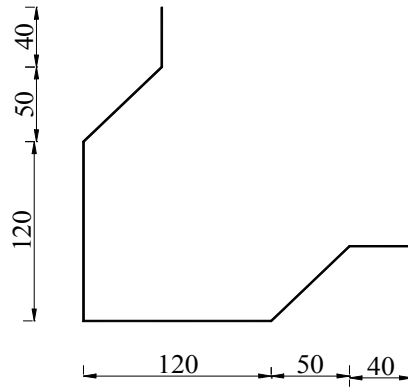

CORNER TRIM

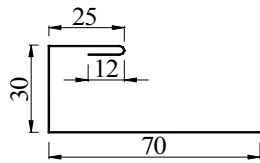

FRAMED OPENING TRIM

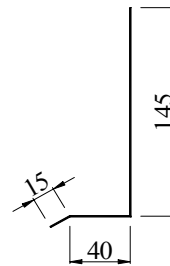

DRIP TRIM

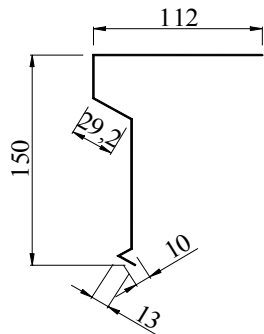

OASIS EAVE TRIM

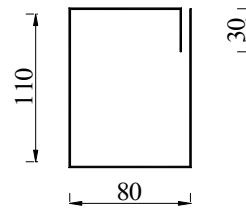

DOWN SPOUT

\*Indicated dimensions may be altered to fit project requirements



# CRANES

# LIGHT CAPACITY SINGLE GIRDER

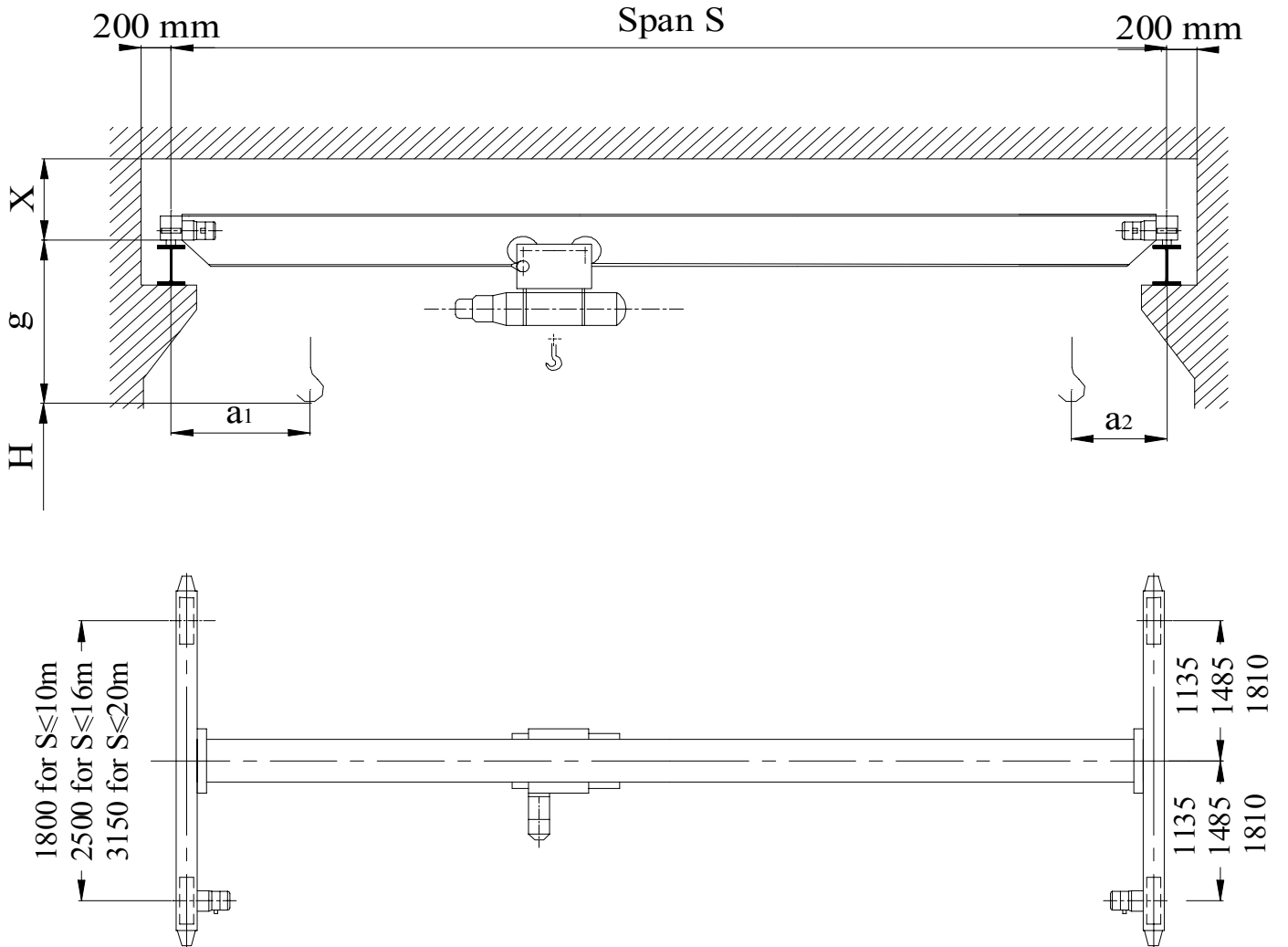

**Wheel loads in kg**

Capacity ton	Wheel Load	Span in Meters							
		6	8	10	12	14	16	18	20
0.5	max.	650	750	800	850	900	950	1050	1150
	min.	350	350	400	450	500	550	700	750
0.8	max.	800	850	900	950	1000	1050	1200	1200
	min.	350	400	400	450	500	550	700	750
1.0	max.	950	1000	1050	1150	1200	1250	1400	1500
	min.	350	400	450	500	550	600	750	800
1.6	max.	1200	1250	1300	1400	1450	1500	1650	1700
	min.	400	400	450	500	550	600	800	850
2.0	max.	1500	1600	1650	1750	1850	1900	2050	2150
	min.	450	450	500	550	600	650	850	950
3.2	max.	2200	2300	2400	2500	2600	2700	2800	2900
	min.	600	600	650	700	800	900	1000	1100
4.0	max.	2450	2550	2650	2800	2850	2900	3100	3200
	min.	600	600	600	650	800	900	1000	1150
5.0	max.	3000	3150	3300	3400	3500	3550	3750	3900
	min.	750	750	750	750	850	950	1100	1300
6.3	max.	3600	3800	3900	4000	4100	4350	4400	4500
	min.	800	800	850	900	1000	1100	1300	1500

# LIGHT CAPACITY SINGLE GIRDER

## Dimensions

Capacity	H <sub>max.</sub>	S (up to)	g	a <sub>1</sub>	a <sub>2</sub>
ton	m	m	mm	mm	mm
0.5	7.0	15.2	850	600	525
		17.0	950	600	600
		18.5	950	600	600
		20.0	1050	775	775
0.8	7.0	14.3	850	600	525
		17.0	950	600	600
		20.0	1050	775	775
1.0	7.0	13.0	850	600	525
		16.0	950	600	600
		19.0	1050	775	775
		20.0	1150	1000	1000
1.6	3.5	11.8	825	600	525
		15.0	925	600	600
		17.0	1025	775	775
		20.0	1125	1000	1000
1.6	7.0	11.8	1000	650	600
		17.0	1100	650	600
		20.0	1200	800	800
2.0	3.5	12.0	1300	1000	1000
		13.8	825	600	525
		18.0	925	600	600
		20.0	1025	775	775
2.0	7.0	12.0	1125	1000	1000
		13.8	1000	650	600
		18.0	1100	650	600
		20.0	1200	800	800
3.2	3.5	10.7	1300	1000	1000
		13.6	1000	650	600
		16.4	1100	650	600
		20.0	1200	800	800
3.2	7.0	9.7	1300	1000	1000
		12.5	1200	850	700
		14.4	1300	850	700
		20.0	1400	850	800
4.0	3.5	9.7	1500	1050	1050
		12.5	1000	650	600
		14.4	1100	650	600
		20.0	1200	800	800
4.0	7.0	9.4	1300	1000	1000
		12.0	1200	850	700
		14.8	1300	850	700
		18.0	1400	850	800
		20.0	1500	1050	1050
5.0	8.0	8.3	1375	900	800
		10.9	1475	900	800
		13.8	1575	900	850
		17.0	1675	1050	1050
		20.0	1775	1250	1250
6.3	3.5	8.3	1150	850	700
		10.9	1250	850	700
		13.8	1350	850	800
		17.0	1450	1000	1000
		20.0	1550	1200	1200
6.3	8.0	8.3	1375	900	800
		10.9	1475	900	800
		13.8	1575	900	850
		17.0	1675	1050	1050
		20.0	1775	1250	1250

# NORMAL CAPACITY DOUBLE GIRDER

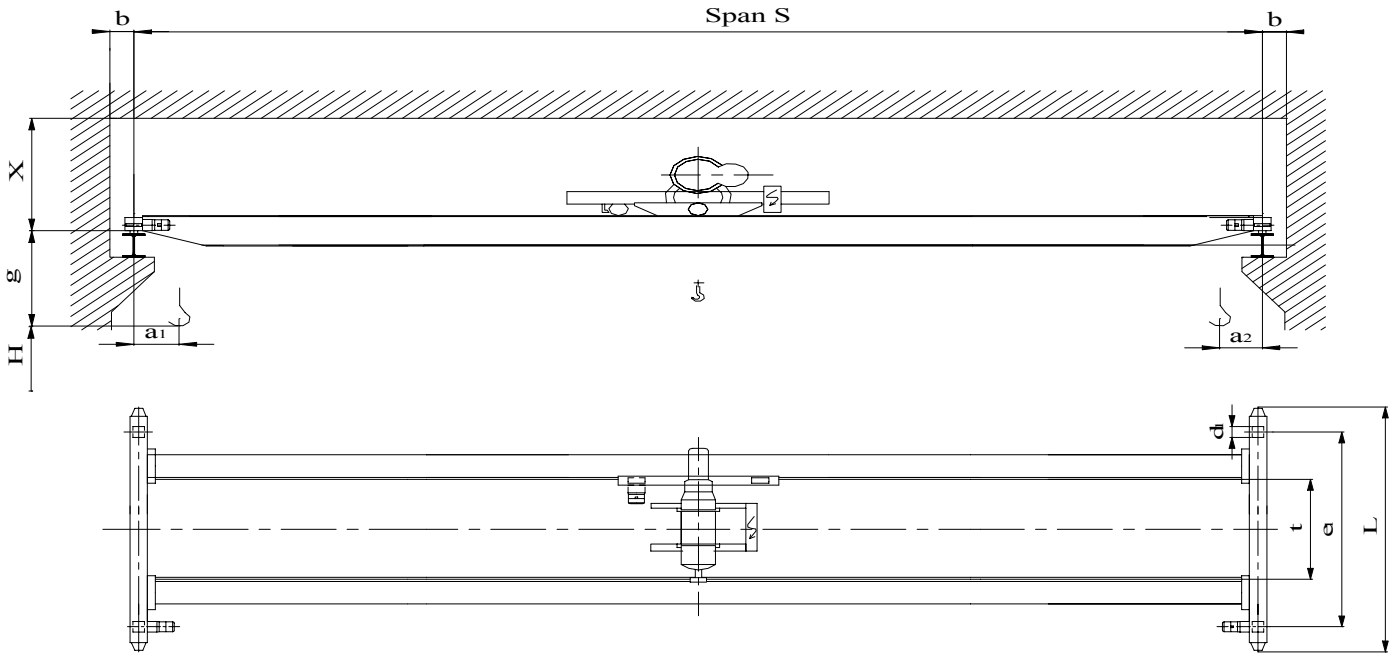

**Wheel loads in kg**

Capacity ton	Wheel Load	Span in Meters												
		6	8	10	12	14	16	18	20	22	24	26	28	30
2.0	max.	1450	1550	1600	1750	1900	2000	2150	2250	2950	3050	3350	3600	3900
	min.	450	500	500	600	750	800	950	1050	1700	1850	2100	2400	2300
3.2	max.	2050	2200	2300	2400	2550	2650	2850	3100	3600	3900	4150	4300	4600
	min.	550	550	550	650	750	850	1000	1250	1750	2000	2250	2400	2700
4.0	max.	2450	2550	2700	2800	3000	3150	3350	3550	4050	4300	4600	4850	5150
	min.	600	600	650	650	800	900	1100	1300	1750	2000	2250	2550	2800
5.0	max.	2900	3100	3250	3400	3550	3750	3950	4150	4650	4850	5200	5400	5750
	min.	650	650	700	750	850	1000	1200	1350	1850	2000	2400	2550	2900
6.3	max.	3550	3750	3900	4100	4250	4450	4700	4900	5350	5600	5900	6150	6450
	min.	750	700	750	850	950	1100	1300	1500	1900	2150	2400	2650	2900
8.0	max.	4600	4850	5050	5250	5450	5700	6050	6300	6550	6800	7100	7500	7800
	min.	950	900	950	1000	1150	1300	1650	1800	2000	2250	2550	2900	3200
10.0	max.	5550	5850	6100	6300	6600	6850	7150	7450	7650	7950	8350	8650	8950
	min.	1100	1050	1050	1150	1350	1500	1750	2000	2150	2400	2750	3050	3350
12.5	max.	6500	6900	7200	7500	7800	8100	8400	8650	9000	9300	9700	10100	10550
	min.	1500	1400	1350	1450	1600	1750	1950	2150	2450	2700	3000	3400	3850
16.0	max.	8350	8800	9200	9700	9900	10350	10600	11000	11300	11700	12150	12600	13000
	min.	1850	1600	1600	1800	1900	2050	2250	2550	2750	3100	3500	3900	4250
20.0	max.	10300	10850	11300	11700	12000	12350	12750	13150	13550	14100	14400	15250	1550
	min.	2350	2100	2050	2050	2150	2300	2550	2850	3200	3650	3900	4650	4950
25.0	max.	11900	12900	13600	14150	14600	15150	15550	16000	16550	16950			
	min.	3950	3350	3050	2950	2950	3100	3250	3500	3900	4150			

## NORMAL CAPACITY DOUBLE GIRDER

### Dimensions

Capacity	H <sub>max.</sub>	S (up to)	g	a <sub>1</sub>	a <sub>2</sub>	e <sub>1</sub>	L	d <sub>1</sub>	t	x	b
ton	m	m	mm	mm	mm	mm	mm	mm	mm	mm	mm
2.0	3.5	12	0	750	750	2000	2470	250	1000	920	200
		20	50	900	750	3150	3620	250	1400	920	200
		25	-50	1100	750	4000	4560	400	2240	1040	200
		30	-50	1100	750	4560	5210	400	2800	1040	200
	7	12	150	750	750	2000	2470	250	1000	990	200
		20	150	900	750	3150	3620	250	1400	990	200
3.2	3.5	25	50	1100	750	4000	4560	400	2240	1100	200
		30	50	1100	750	4560	5210	400	2800	1100	200
		12	300	750	750	2000	2470	250	1000	1055	200
		20	300	900	750	3150	3620	250	1400	1055	200
	7	25	200	1100	750	4000	4560	400	2240	1065	200
		30	200	1100	750	4560	5210	400	2800	1065	200
4.0	3.5	12	150	750	750	2000	2470	250	1000	990	200
		20	150	900	750	3150	3620	250	1400	990	200
		25	50	1100	750	4000	4560	400	2240	1100	200
		30	50	1100	750	4560	5210	400	2800	1100	200
	7	12	300	750	750	2000	2470	250	1000	1055	200
		20	300	900	750	3150	3620	250	1400	1055	200
5.0	8	25	200	1100	750	4000	4560	400	2240	1065	200
		30	200	1100	750	4560	5210	400	2800	1065	200
		12	350	750	750	2000	2470	250	1000	1115	200
		16	350	750	750	2500	2970	250	1400	1115	200
	20	350	900	750	3150	3620	250	1400	1115	200	
		300	1100	750	4000	4560	400	2240	1225	200	
6.3	3.5	30	300	1100	750	4560	5210	400	2800	1225	200
		12	200	750	750	2000	2470	250	1000	1050	200
		16	200	750	750	2500	2970	250	1400	1050	200
		20	200	900	750	3150	3620	250	1400	1050	200
	8	25	100	1100	750	4000	4560	400	2240	1160	200
		30	100	1100	750	4560	5210	400	2800	1160	200
8.0	3.5	12	300	750	750	2000	2470	250	1000	1115	200
		16	300	750	750	2500	2970	250	1400	1115	200
		20	300	900	750	3150	3620	250	1400	1115	200
		25	200	1100	750	4000	4560	400	2240	1225	200
	8	30	200	1100	750	4560	5210	400	2800	1225	200
		16	100	750	750	2500	3150	400	1400	1165	200
10.0	3.5	20	100	900	750	3150	3800	400	1400	1165	200
		25	100	1100	750	4000	4650	400	2240	1165	200
		30	100	1100	750	4560	5210	400	2800	1165	200
		16	450	750	750	2500	3150	400	1400	1355	200
	12	20	450	900	750	3150	3800	400	1400	1355	200
		25	450	1100	750	4000	4650	400	2240	1355	200
12.5	4	30	450	1100	750	4560	5210	400	2800	1355	200
		16	200	750	750	2500	3150	400	1400	1225	200
		20	200	900	750	3150	3800	400	1400	1225	200
		25	200	1100	750	4000	4650	400	2240	1225	200
	12	30	200	1100	750	4560	5210	400	2800	1225	200
		14	-150	900	900	2500	3150	400	1400	1385	200
16.0	6	20	-150	900	900	3150	3800	400	1400	1385	200
		25	-150	1000	900	4000	4650	400	2240	1385	200
		30	-250	1100	900	4560	5350	500	2800	1485	200
		14	50	900	900	2500	3150	400	1400	1500	200
	6	20	50	900	900	3150	3800	400	1400	1500	200
		25	50	1000	900	4000	4650	400	2240	1500	200
20.0	6	30	-50	1100	900	4560	5350	500	2800	1600	250
		11	50	900	900	2500	3150	400	1400	1470	200
		25	-50	900	900	4000	4790	500	2240	1600	250
25.0	6	30	-50	900	900	4560	5350	500	2800	1600	250
		20	100	1350	1350	4000	4790	500	2240	1850	250
		25	100	1350	1350	4000	4790	500	2240	1850	250

negative (g) dimensions = hook above crane rail

# HEAVY CAPACITY DOUBLE GIRDER

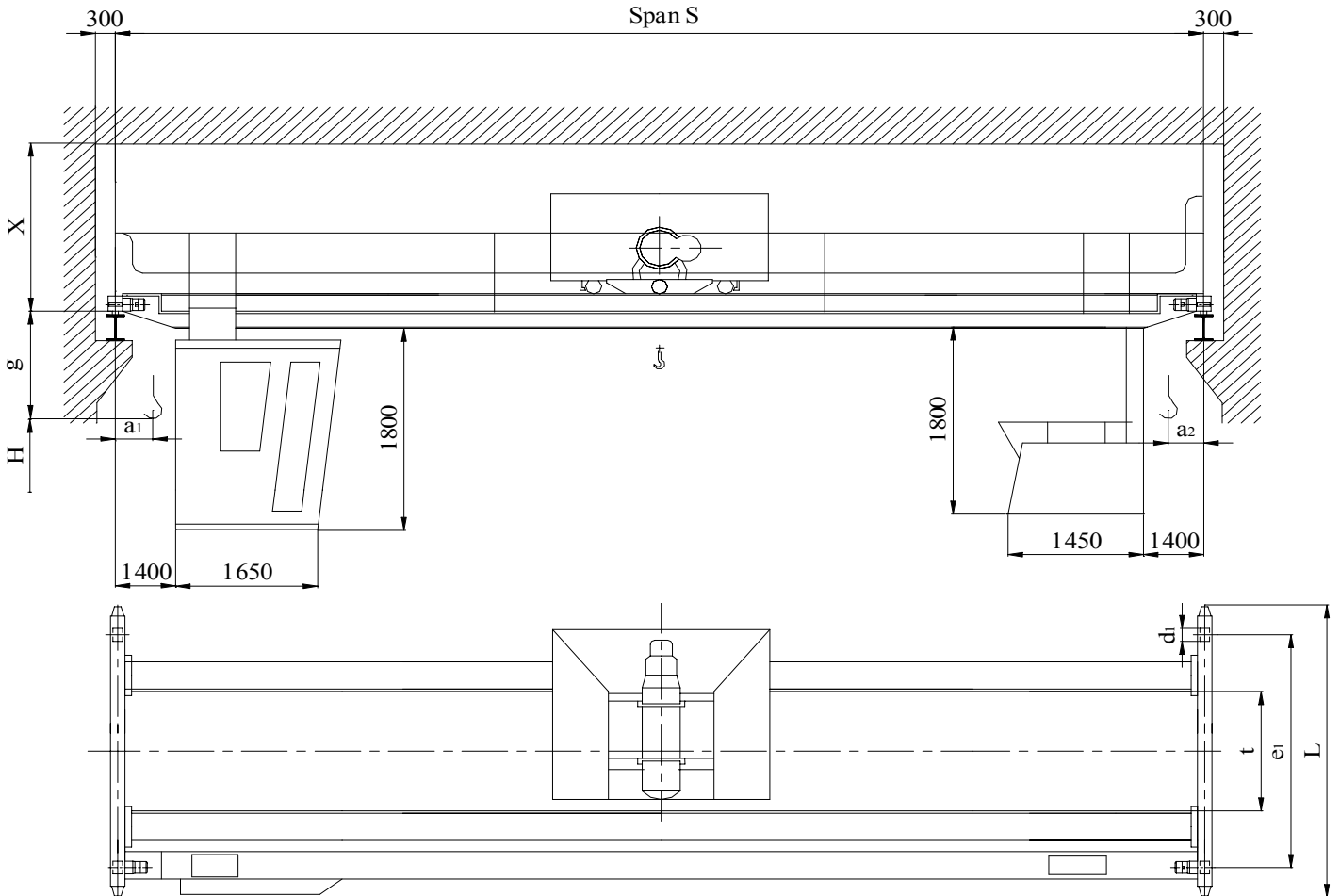

## Wheel loads in kN

Capacity ton	Wheel Load	Span in Meters												
		6	8	10	12	14	16	18	20	22	24	26	28	30
25	max.	13100	14300	15100	15800	16500	17100	17500	18200	1900	19900	21100	21800	22500
	min.	4900	4200	3800	3600	3600	3700	3500	4000	4300	4900	5800	6300	6800
32	max.	15700	17100	18100	19000	19700	20400	21000	21700	22600	23700	24600	25300	26300
	min.	5800	4800	4400	4200	4100	4100	4200	4500	5000	5700	6200	6600	7400
40	max.	18600	20300	21500	22600	23400	24400	25200	26100	27000	27900	28900	29700	30600
	min.	7200	5900	5200	4900	4800	4900	5100	5500	5900	6400	6900	7400	8100
50	max.	23300	25500	27000	28300	29400	30400	31700	32400	33400	34300	35100	35900	37200
	min.	9000	7200	6400	5900	5800	5800	6300	6600	6800	7200	7500	8000	9000
63	max.	28100	30900	32800	34300	35500	37000	38000	39000	40000	41000	42000	42900	44000
	min.	10700	8700	7700	7100	6900	7100	7200	7700	7800	8200	8600	9200	10000

# HEAVY CAPACITY DOUBLE GIRDER







## Dimensions

Capacity	H <sub>max.</sub>	S (up to)	g	e <sub>1</sub>	L	d <sub>1</sub>	t	X
ton	m	m	mm	mm	mm	mm	mm	mm
25	10	25	530	3950	5280	630	1800	2480
	15	25	530	4500	5830	630	2800	2480
	20	25	530	4850	6180	630	3150	2480
	10	30	530	4500	5830	630	1800	2480
	15	30	530	5500	6830	630	2800	2480
	20	30	530	5850	7180	630	3150	2480
32	10	22	530	3500	4830	630	1800	2480
	15	22	530	4500	5830	630	2800	2480
	20	22	530	4850	6180	630	3150	2480
	10	24	530	3950	5280	630	1800	2480
	15	24	530	4500	5830	630	2800	2480
	20	24	530	4850	6180	630	3150	2480
40	10	30	530	4500	5830	630	1800	2480
	15	30	530	5500	6830	630	2800	2480
	20	30	530	5850	7180	630	3150	2480
	10	23	530	3500	4830	630	1800	2480
	15	23	530	4500	5830	630	2800	2480
	20	23	530	4850	6180	630	3150	2480
50	10	24	530	4500	5830	630	1800	2480
	15	24	530	5500	6830	630	2800	2480
	20	24	530	5850	7180	630	3150	2480
	10	30	530	4500	5830	630	1800	2560
	15	30	530	5500	6830	630	2800	2560
	20	30	530	5850	7180	630	3150	2560
63	10	13	770	3500	4830	630	1800	2480
	15	13	770	4500	5830	630	2800	2480
	20	13	770	4850	6180	630	3150	2480
	10	19	770	3500	4830	630	1800	2480
	15	19	770	4500	5830	630	2800	2480
	20	19	770	4850	6180	630	3150	2480
63	10	30	770	4500	5830	630	1800	2480
	15	30	770	5500	6830	630	2800	2480
	20	30	770	5850	7180	630	3150	2480
	10	8	770	3500	4830	630	1800	2480
	15	8	770	4500	5830	630	2800	2480
	20	8	770	4850	6180	630	3150	2480
63	10	14	770	3500	4830	630	1800	2480
	15	14	770	4500	5830	630	2800	2480
	20	14	770	4850	6180	630	3150	2480
	10	19	770	4500	5830	630	1800	2480
	15	19	770	5500	6830	630	2800	2480
	20	19	770	5850	7180	630	3150	2480
63	10	30	690	4700	6150	710	1800	2560
	15	30	690	5700	7150	710	2800	2560
	20	30	690	6050	7500	710	3150	2560
	20	30	690	6050	7500	710	3150	2560

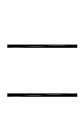

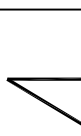
# WELDING SYMBOLS

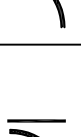

## BASIC WELD SYMBOLS

		GROOVE OR BUTT							
		PLUG OR SLOT	SQUARE	V	BEVEL	U	J	FLARE V	FLARE BEVEL
BACK	FILLET								

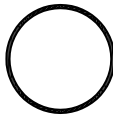
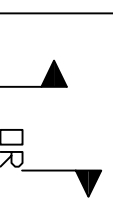
## SUPPLEMENTARY WELD SYMBOLS

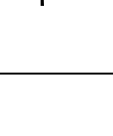
WELD ALL AROUND	*FIELD WELD	CONTOUR	
		FLUSH	CONVEX
			

### NOTE :

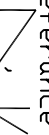
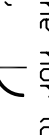
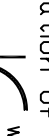
Size , weld symbol, length of weld and spacing must be read in that order from left to right along the reference line.  
 Neither orientation of reference line nor location of the arrow alter this rule.  
 The perpendicular leg of  ,  ,  weld symbols must be at left.  
 Size and spacing of fillet welds must be shown on both the Arrow Side and the other Side symbol.  
 Symbol applied between abrupt changes direction of welding unless governed by the "all around" symbol or otherwise dimensioned.

# WELDING SYMBOLS

<p><b>DOUBLE-FILLET SYMBOL</b></p> <p>SIZE (LENGTH OF LEG) — 1/8 — 300 — 300 — LENGTH-OMISSION INDICATES THAT WELD EXTENDS BETWEEN ABRUPT CHANGES IN DIRECTION OR AS DIMENSIONED</p> <p>LENGTH OF INCREMENTS</p>	<p><b>SQUARE-GROOVE WELDING SYMBOL</b></p> <p>1/8 — ROOT OPENING</p> <p>OMISSION OF SIZE INDICATES COMPLETE JOINT PENETRATION</p>
<p><b>CHAIN-INTERMITTENT-FILLET WELDING SYMBOL</b></p> <p>SIZE (LENGTH OF LEG) — 1/8 — 80-150 — 80-150 — LENGTH OF INCREMENTS</p> <p>LENGTH OF INCREMENTS</p>	<p><b>SINGLE-V GROOVE WELDING SYMBOL</b></p> <p>SIZE (DEPTH OF CHAMFERING) — 1/8 — 1/2 — 1/8 — 60° — ROOT OPENING — GROOVE ANGLE</p> <p>OMISSION INDICATES DEPTH OF CHAMFERING EQUAL TO THICKNESS OF MEMBER</p> <p>ROOT OPENING</p> <p>GROOVE ANGLE</p>
<p><b>STAGGERED INTERMITTENT-FILLET WELDING SYMBOL</b></p> <p>SIZE (LENGTH OF LEG) — 1/2 — 80-200 — 80-200 — LENGTH OF INCREMENTS</p> <p>LENGTH OF INCREMENTS</p>	<p><b>SINGLE-V GROOVE WELDING SYMBOL INDICATING ROOT PENETRATION</b></p> <p>DEPTH SIZE OF PENETRATION — 10(12) — 1/8 — 90° — ROOT OPENING — GROOVE ANGLE</p> <p>EFFECTIVE THROAT</p>
<p><b>BEAD WELD SYMBOL INDICATING BEAD TYPE BACK WELD</b></p> <p>ANY APPLICABLE SINGLE GROOVE WELD SYMBOL</p>	<p><b>DOUBLE-BEVEL GROOVE WELDING SYMBOL</b></p> <p>DEPTH OF FILLING — 25 — 25 — 50° — 40° — ROOT OPENING — GROOVE ANGLE</p> <p>ARROW POINTS TOWARD MEMBER TO BE CHAMFERED</p>
<p><b>DUAL BEAD WELD SYMBOL INDICATING BUILT-UP SURFACE</b></p> <p>SIZE (HEIGHT OF DEPOSIT) — 4 — ORIENTATION, LOCATION AND ALL DIMENSIONS OTHER THAN SIZE ARE SHOWN ON THE DRAWING.</p> <p>PITCH (DISTANCE BETWEEN CENTERS OF INCREMENTS)</p>	<p><b>PLUG WELDING SYMBOL</b></p> <p>INCLUDED ANGLE OF COUNTERSINK — 1/2 — 150 — 1/2 — DEPTH OF FILLING — OMISSION INDICATES FILLING IS COMPLETE — PITCH (DISTANCE BETWEEN CENTERS OF WELDS)</p>
<p><b>SEAM WELDING SYMBOL</b></p> <p>SIZE (WIDTH OF WELD) — 6 — 75-225 — 75-225 — LENGTH OF WELDS OR INCREMENTS — OMISSION INDICATES THAT WELD EXTENDS BETWEEN ABRUPT CHANGES IN DIRECTION OR AS DIMENSIONED</p> <p>MIN. ACCEPTABLE SHEAR RESISTANCE MAY BE USED INSTEAD</p> <p>PITCH (DISTANCE BETWEEN CENTERS OF INCREMENTS)</p>	<p><b>SLOT WELDING SYMBOL</b></p> <p>DEPTH OF FILLING — 1/8 — 1/8 — 1/8 — ORIENTATION, LOCATION AND ALL DIMENSIONS OTHER THAN SIZE ARE SHOWN ON THE DRAWING.</p> <p>PITCH (DISTANCE BETWEEN CENTERS OF INCREMENTS)</p>

# WELDING SYMBOLS

<p><b>WELD-THROUGH SYMBOL</b></p>	<p>ANY APPLICABLE WELD SYMBOL</p>	<p><b>WELDING SYMBOLS FOR COMBINED WELDS</b></p>
<p><b>FLUSH CONTOUR SYMBOL</b></p> <p>FLUSH CONTOUR SYMBOL INDICATES FACE OF WELD TO BE MADE FLUSH WHEN USED WITHOUT A FINISH SYMBOL. INDICATES WELD WITHOUT SUBSEQUENT FINISHING</p>	<p>FINISH SYMBOL (USER'S STANDARD) INDICATES METHOD OF OBTAINING SPECIFIED CONTOUR BUT NOT DEGREE OF FINISH</p>	<p><b>JOINT WITH BACKING</b></p> <p style="text-align: center;">NOTE : DIMENSIONS OF BAKING AS SPECIFIED</p>
<p><b>FIELD WELD SYMBOL</b></p> <p>FIELD WELD SYMBOL INDICATES THAT WELD IS TO BE MADE AT A PLACE OTHER THAN OF INITIAL CONSTRUCTION</p>	<p><b>COMPLETE PENETRATION</b></p> <p>INDICATES COMPLETE PENETRATION REGARDLESS OF TYPE OF WELD OR JOINT PREPARATION</p>	<p><b>JOINT WITH SPACER</b></p> <p>TYPE OF SPACER</p> <p>(1) SPACER DIMENSIONS</p> <p>LETTER DESIGNATIONS</p> <p>S- STEEL OR OTHER MATERIAL AS SPECIFIED</p> <p>SR- SAME AS (S) BUT REMOVE AFTER WELDING</p> <p>T-TAPE</p> <p>F-FLUX</p>
<p><b>SUPPLEMENTARY SYMBOLS</b></p>		
<p><b>WELD - ALL AROUND</b></p>	<p><b>FIELD WELD</b></p>	<p><b>WELD THROUGH</b></p>
<p><b>BACKING, SPACER</b></p>	<p><b>CONTOUR</b></p>	
<p><b>FLUSH</b></p>	<p><b>CONVEX</b></p>	<p><b>CONCAVE</b></p>
<p><b>JOINT PREPARATION</b></p> <p>PREPARATION AFTER FITTING (AND WELDING ON "ARROW SIDE" IF CALLED FOR IN THE WELDING PROCEDURE)</p> <p>PREPARATION PRIOR TO FITTING</p>		

# MISCELLANEOUS

# AIRCRAFT HANGERS

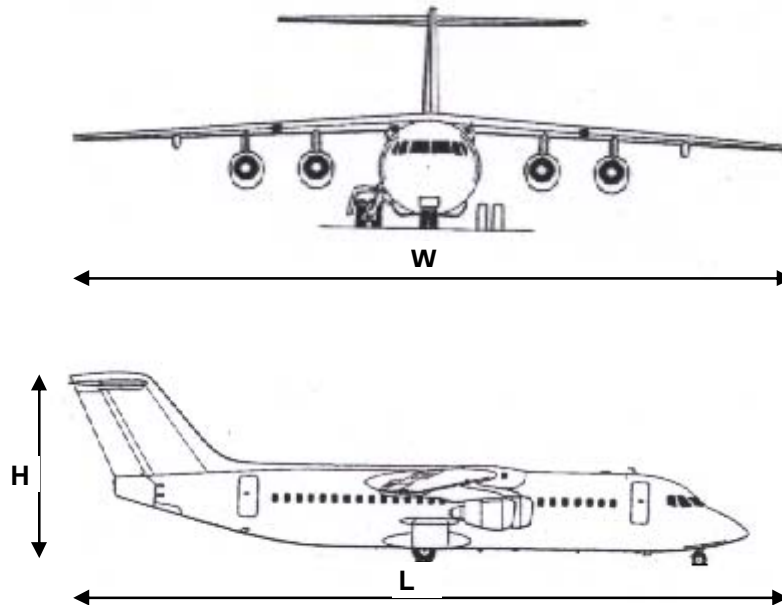

## Dimensions

TYPE OF AIRCRAFT	L (m)	W (m)	H (m)
BOING 727-200	46.680	32.920	8.660
BOING 737-500	29.790	28.890	8.660
BOEING 747-400 COMBI	68.600	64.940	19.580
BOEING 757-200	47.320	38.049	13.564
BOEING 767-300	54.940	47.574	15.849
AIRBUS A340-200	59.422	58.640	16.918
AIRBUS A340-300	63.658	60.304	16.828
McDONNELL-DOUGLAS DC-8-70	57.125	45.237	12.929
McDONNELL-DOUGLAS DC-9-80	45.020	32.850	9.200
McDONNELL-DOUGLAS DC-10	55.499	50.934	17.704
FASLCON 900	19.550	19.330	7.550
LOCKHEAD C-5A GALAXY	75.540	67.882	19.850
LOCKHEAD C-130 HERCULES	29.794	40.411	11.659
LOCKHEAD -141 STRLIFTER	51.178	48.743	11.976
LOCKHEAD L-1011	54.178	47.346	16.866
CONCORDE	62.103	25.552	11.405

# Common Conversion Factors

Item	Imperial or Metric to SI	SI to Imperial or Metric
<b>Length</b>	1 ft. = 0.3048 m 1 in. = 25.4 mm 1 in. = 2.54 cm 1 yd. = 0.914 m 1 mile = 1.609344 km	1 m = 3.28 ft. 1 mm = 0.0394 in. 1 in. = 0.3937 cm 1 m = 1.09 yd. 1 km = 0.622 mi.
<b>Area</b>	1 acre = 0.404685 6 ha 1 ft. <sup>2</sup> = 0.09290304 m <sup>2</sup> 1 in. <sup>2</sup> = 645.16 mm <sup>2</sup> 1 in. <sup>2</sup> = 6.4516 cm <sup>2</sup> 1 mi. <sup>2</sup> = 2.589 988 km <sup>2</sup> 1 yd. <sup>2</sup> = 0.836127 m <sup>2</sup>	1 ha = 2.471 acres 1 m <sup>2</sup> = 10.764 ft. <sup>2</sup> 1 mm <sup>2</sup> = 1.55x 10 <sup>-3</sup> in. <sup>2</sup> 1 cm <sup>2</sup> = 0.155 in. <sup>2</sup> 1 km <sup>2</sup> = 0.3861 mi. <sup>2</sup> 1 m <sup>2</sup> = 1.20 yd. <sup>2</sup>
<b>Volume</b>	1 in. <sup>3</sup> = 16387.064mm. <sup>3</sup> 1 in. <sup>3</sup> = 16.387064 cm <sup>3</sup> 1 ft. <sup>3</sup> = 28.316 85m. <sup>3</sup> 1 yd. <sup>3</sup> = 0.764 555m. <sup>3</sup>	1 mm <sup>3</sup> = 0.061 x10 <sup>-3</sup> in. <sup>3</sup> 1 cm <sup>3</sup> = 0.061 in. <sup>3</sup> 1 dm <sup>3</sup> = 0.0353 ft. <sup>3</sup> 1 m <sup>3</sup> = 1.308 yd. <sup>3</sup>
<b>Mass</b>	1 lb. = 0.45359237 kg 1 ton = 0.90718474 Mg	1 kg = 2.20 lb. 1 Mg = 1.10 ton =2200 lb.
<b>Mass per unit Length</b>	1 lb./in. = 17.858 kg/m 1 lb./ ft. = 1.48816 kg/m 1 lb./yd. = 0.496055 kg/m	1 kg/m = 0.056 lb./in. 1 kg/m = 0.672 lb./ft. 1 kg/m = 2.016 lb./yd.
<b>Mass per unit Area</b>	1 lb./ ft. <sup>2</sup> = 4.88243 kg/m <sup>2</sup> 1 lb./ ft. <sup>2</sup> = 4.88243 x10 <sup>-4</sup> kg/cm <sup>2</sup> 1 oz./ft. <sup>2</sup> = 305.152 g/m <sup>2</sup> 1 lb./in. <sup>2</sup> = 703.0696 kg/m <sup>2</sup>	1 kg/m <sup>2</sup> = 0.2051 lb./ft. <sup>2</sup> 1 kg/cm <sup>2</sup> = 2051 lb./ft. <sup>2</sup> 1 g/m <sup>2</sup> = 3.277X10 <sup>-3</sup> oz./ft. <sup>2</sup> 1 kg/m <sup>2</sup> = 1.42X 10 <sup>-3</sup> lb./in. <sup>2</sup>
<b>Mass per unit volume</b>	1 lb./ft. <sup>3</sup> = 16.01846 kg/m <sup>3</sup> 1 lb./in. <sup>3</sup> = 27.67990 Mg/m <sup>3</sup>	1 kg/m <sup>3</sup> = 62.4X10 <sup>-3</sup> lb./ft. <sup>3</sup> 1 Mg/m <sup>3</sup> = 0.0361 lb./in. <sup>3</sup>
<b>Force</b>	1 kg force = 9.80665 N 1 Kip = 4.448222 kN 1 pound force = 4.448222 N	1 N = 0.1019716 kg force 1 kN = 0.225 Kip 1 N = 0.225 pound force
<b>Torque or Moment of Force</b>	1 pound-force foot = 1.355818 N.m 1 pound-force inch = 0.112985 N.m	1 N.m = 0.737562 pound-force foot 1 N.m = 8.850732 pound-force inch
<b>Pressure or Stress</b>	1 psf = 47.88026 pa 1 psi = 6.894757 kpa 1 ksi = 6.894757 Mpa 1 kg/cm <sup>2</sup> = 0.0980665 Mpa 1 t/cm <sup>2</sup> = 98.0665 Mpa	1 pa = 0.0209 psf 1 kpa = 0.145 psi 1 Mpa = 0.145 ksi 1 Mpa = 10.19 kg/cm <sup>2</sup> 1 Mpa = 0.01019 t/cm <sup>2</sup>
<b>Moment of inertia</b> a) second Moment of Area b) section Modulus	1 in. <sup>4</sup> = 416231.4 mm <sup>4</sup> 1 in. <sup>4</sup> = 41.62314 cm <sup>4</sup> 1 in. <sup>3</sup> =16387.064 mm <sup>3</sup> 1 in. <sup>3</sup> = 16.387064 cm <sup>3</sup>	1 mm <sup>4</sup> = 2.4 x10 <sup>-6</sup> in. <sup>4</sup> 1 cm <sup>4</sup> = 0.024 in. <sup>4</sup> 1 cm <sup>4</sup> = 0.024 in. <sup>4</sup> 1 mm <sup>3</sup> = 0.061 x10 <sup>-3</sup> in. <sup>3</sup> 1 cm <sup>3</sup> = 0.061 in. <sup>3</sup>

# PROPERTIES OF GEOMETRIC SECTIONS AND STRUCTURAL SHAPES

$$A = bd$$

$$c = \frac{d}{2}$$

$$I = \frac{bd^3}{12}$$

$$S = \frac{bd^2}{6}$$

$$r = \frac{d}{\sqrt{12}}$$

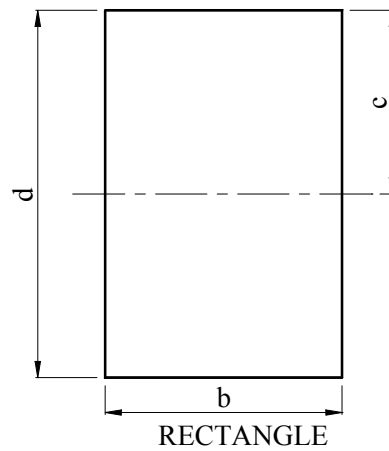

$$A = \frac{bd}{2}$$

$$c = 2d/3$$

$$I = \frac{bd^3}{36}$$

$$S = \frac{bd^2}{24}$$

$$r = \frac{d}{\sqrt{18}}$$

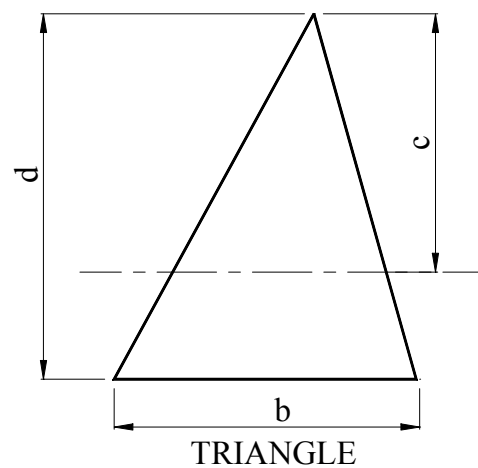

$$A = \frac{d(b + b_1)}{2}$$

$$c = \frac{d(2b + b_1)}{3(b + b_1)}$$

$$I = \frac{d^3(b^2 + 4bb_1 + b_1^2)}{36(b + b_1)}$$

$$S = \frac{d^2(b^2 + 4bb_1 + b_1^2)}{12(2b + b_1)}$$

$$r = \frac{d}{6(b + b_1)} \sqrt{2(b^2 + 4bb_1 + b_1^2)}$$

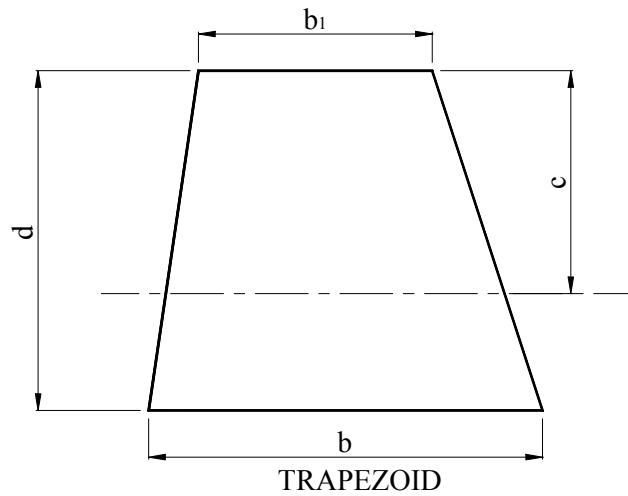

$$A = \frac{\pi d^2}{4} = \pi R^2$$

$$c = \frac{d}{2} = R$$

$$I = \frac{\pi d^4}{64} = \frac{\pi R^4}{4}$$

$$S = \frac{\pi d^3}{32} = \frac{\pi R^3}{4}$$

$$r = \frac{d}{4} = \frac{R}{2}$$

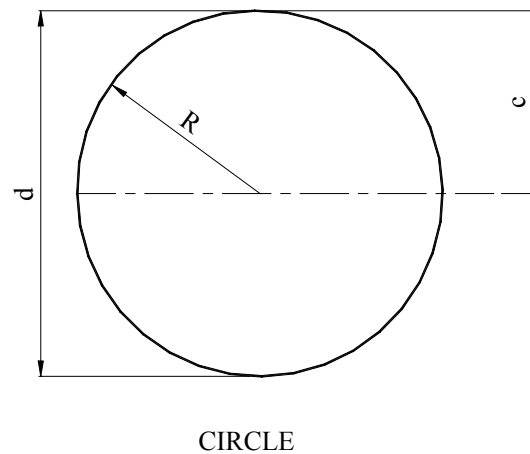



$$A = \frac{\pi(d^2 - d_1^2)}{4}$$

$$c = \frac{d}{2}$$

$$I = \frac{\pi(d^4 - d_1^4)}{64}$$

$$S = \frac{\pi(d^4 - d_1^4)}{32d}$$

$$r = \frac{\sqrt{d^2 + d_1^2}}{4}$$

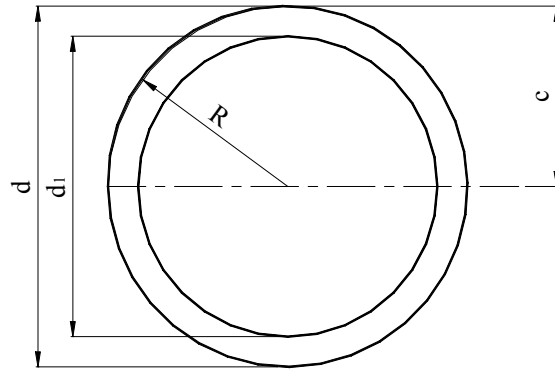

HOLLOW CIRCLE

$$A = \pi Dt = 2\pi Rt$$

$$c = R$$

$$I = \pi D^3 t / 8$$

$$S = \pi D^2 t / 8$$

$$r = D / \sqrt{8}$$

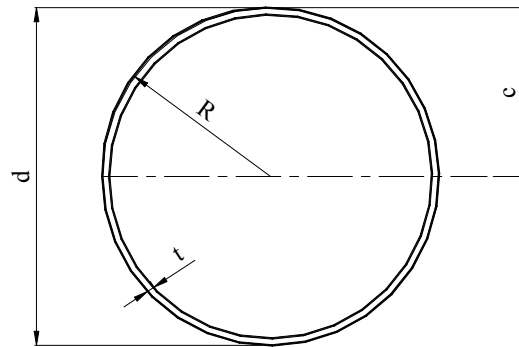

THIN WALLED SECTION

$$h = d + 2t$$

$$b_o = a + 2b$$

$$A_1 = b_1 t$$

$$A = 2(A_1 + A_2)$$

$$I_{xx} = 2I_{xc} + \frac{b_1}{12} [h^3 - d^3]$$

$$S_{xx} = 2I_{xx}/h$$

$$r_{xx} = \sqrt{I_{xx}/A}$$

$$I_{yy} = 2I_{yc} + \frac{A_1}{6} b_1^2 + 2A_2 (x + a/2)^2$$

$$S_{yy} = 2I_{yy}/b_o \quad \text{if } b_1 < b_o$$

$$S_{yy} = 2I_{yy}/b_1 \quad \text{if } b_1 \geq b_o$$

$$r_{yy} = \sqrt{I_{yy}/A}$$

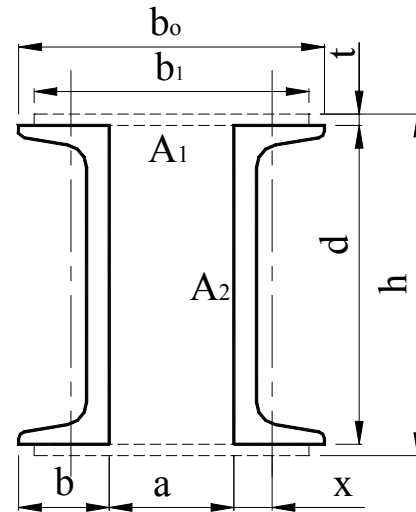

$$h = d + 2t$$

$$A_1 = b_1 t$$

$$A = 2(A_1 + A_2)$$

$$I_{xx} = 2I_{xc} + \frac{b_1}{12} (h^3 - d^3)$$

$$S_{xx} = 2I_{xx}/h$$

$$r_{xx} = \sqrt{I_{xx}/A}$$

$$I_{yy} = 2I_{yc} + \frac{A_1}{6} b_1^2 + 2A_2 (a/2 - x)^2$$

$$S_{yy} = 2I_{yy}/b_1 \quad \text{if } a < b_1$$

$$S_{yy} = 2I_{yy}/a \quad \text{if } a \geq b_1$$

$$r_{yy} = \sqrt{I_{yy}/A}$$

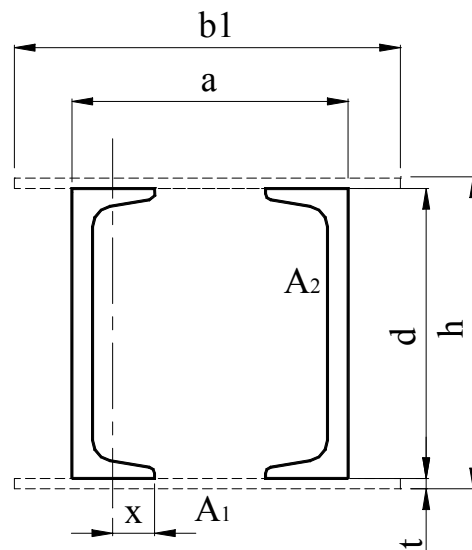

Note: Elements of the shape, which are shown in dotted outline, are continuous and if disconnected the variable defining their size should be set equal to zero.

$$h = d - 2t$$

$$A_1 = bt$$

$$A_2 = wh$$

$$A = 2(A_1 + A_2)$$

$$I_{xx} = \frac{1}{12} \{b(d^3 - h^3) + 2A_2h^2\}$$

$$S_{xx} = 2I_{xx}/d$$

$$r_{xx} = \sqrt{I_{xx}/A}$$

$$c = a - 2w$$

$$I_{yy} = \frac{1}{12} \{2A_1b^2 + h(a^3 - c^3)\}$$

$$S_{yy} = 2I_{yy}/b$$

$$r_{yy} = \sqrt{I_{yy}/A}$$

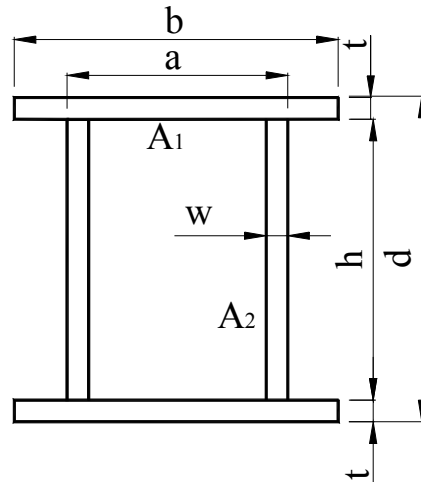

$$h = d - 2t$$

$$A_1 = bt$$

$$A_2 = ht$$

$$A = 2A_1 + 3A_2$$

$$I_{xx} = \frac{1}{12} [3A_2h^2 + b(d^3 - h^3)]$$

$$S_{xx} = 2I_{xx}/d$$

$$r_{xx} = \sqrt{I_{xx}/A}$$

$$I_{yy} = \frac{1}{12} \{2A_1b^2 + A_2t^2 + 2t[b^3 - (b - 2t)^3]\}$$

$$S_{yy} = 2I_{yy}/b$$

$$r_{yy} = \sqrt{I_{yy}/A}$$

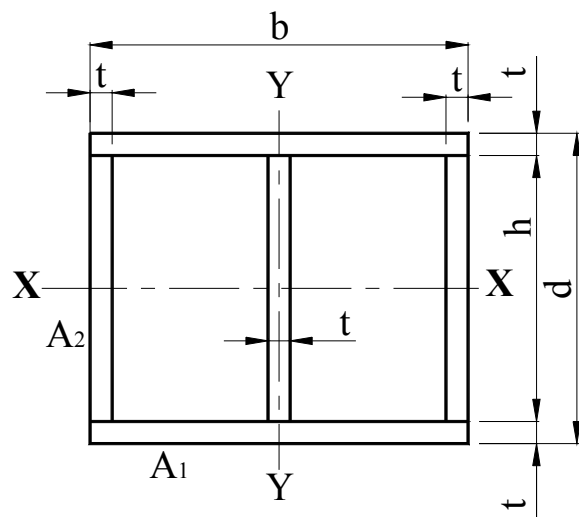

Note: Elements of the shape, which are shown in dotted outline, are continuous and if disconnected the variable defining their size should be set equal to zero.

$$A_1 = bt$$

$$A_2 = (d - w - 2t)w/2$$

$$A_3 = 2A_2 + w^2$$

$$A = 4A_1 + 2A_2 + A_3$$

$$E = d - 2t$$

$$I_x = I_y = \frac{1}{12} \{ b(d^3 - E^3) + wE^3 + 2tb^3 + Ew^3 - w^4 \}$$

$$S_x = S_y = 2I_x/d$$

$$r_x = r_y = \sqrt{I_x/A}$$

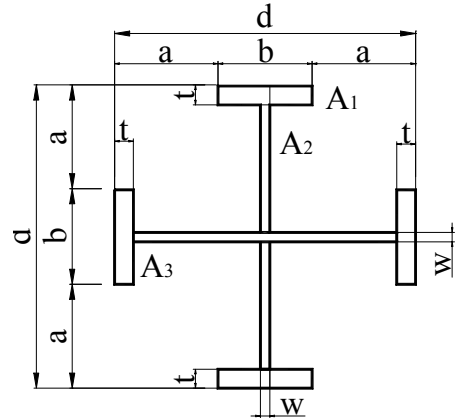

$$h = d - 2w$$

$$A_2 = ht$$

$$A = A_1 + A_2$$

$$I_{xx} = 2I_{yc} + \frac{1}{12} A_2 h^2 + 2A_1 (d/2 - x)^2$$

$$S_{xx} = 2I_{xx}/d$$

$$r_{xx} = \sqrt{I_{xx}/A}$$

$$I_{yy} = 2I_{xc} + \frac{1}{12} A_2 t^2$$

$$S_{yy} = 2I_{yy}/b$$

$$r_{yy} = \sqrt{I_{yy}/A}$$

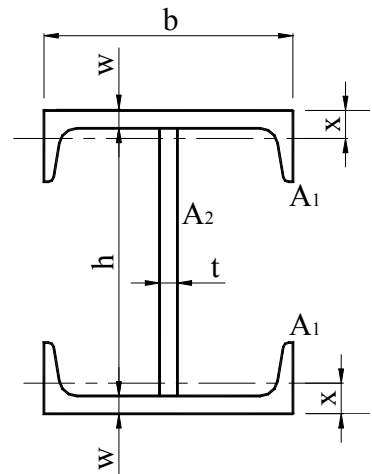

Note: Elements of the shape, which are shown in dotted outline, are continuous and if disconnected the variable defining their size should be set equal to zero.

$$A_2 = bt$$

$$A = 2(A_1 + A_2)$$

$$I_{xx} = 2I_{x1} + \frac{1}{12}b[(d + 2t)^3 - d^3]$$

$$S_{xx} = 2I_{xx}/(d + 2t)$$

$$r_{xx} = \sqrt{I_{xx}/A}$$

$$I_{yy} = 2I_{y1} + \frac{1}{6}A_2t^2 + \frac{1}{2}A_1x^2$$

$$S_{yy} = 2I_{yy}/(x + b_f) \quad \text{if } (x + b_f) > b$$

$$S_{yy} = 2I_{yy}/b \quad \text{if } (x + b_f) \leq b$$

$$r_{yy} = \sqrt{I_{yy}/A}$$

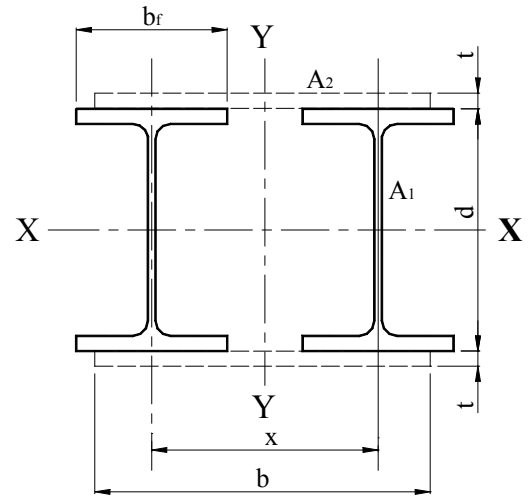

$$d_0 = d + 2t$$

$$A_3 = b_1t$$

$$A = 2(A_1 + A_3) + A_2$$

$$I_{xx} = 2I_{x1} + I_{y2} + \frac{b_1}{12}(d_0^3 - d^3)$$

$$S_{xx} = 2I_{xx}/d_0$$

$$r_{xx} = \sqrt{I_{xx}/A}$$

$$I_{yy} = I_{x2} + 2I_{y1} + \frac{A_3}{6}b_1^2 + A_1b_1^2/2$$

$$S_{yy} = 2I_{xx}/b \quad \text{if } b \geq b_1$$

$$S_{yy} = 2I_{xx}/b_1 \quad \text{if } b < b_1$$

$$r_{yy} = I_{yy}/A$$

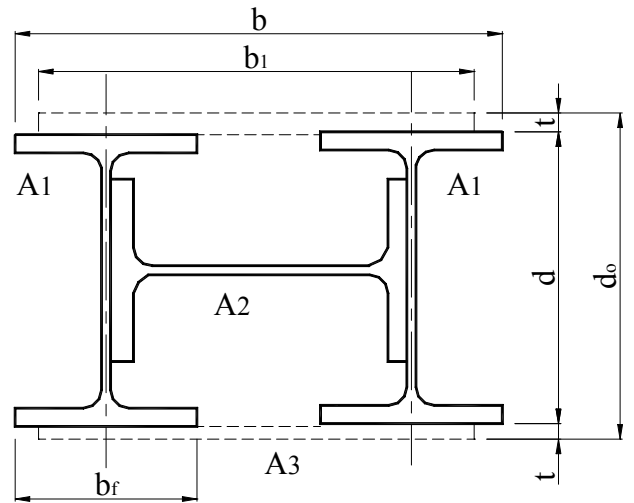

Note: Elements of the shape, which are shown in dotted outline, are continuous and if disconnected the variable defining their size should be set equal to zero.

$$h = d + \frac{1}{2}(b_1 + w_1)$$

$$y_1 = \frac{A_1(d + w_1/2) + A_2d/2}{A_1 + A_2}$$

$$y_2 = h - y_1$$

$$A = A_1 + A_2$$

$$I_{xx} = I_{y1} + I_{x2} + A_1(y_2 - b_1/2)^2$$

$$S_{x1} = I_{xx}/y_1$$

$$S_{x2} = I_{xx}/y_2$$

$$r_{xx} = \sqrt{I_{xx}/A}$$

$$I_{yy} = I_{x1} + I_{y2}$$

$$S_{yy} = 2I_{yy}/b$$

$$r_{yy} = \sqrt{I_{yy}/A}$$

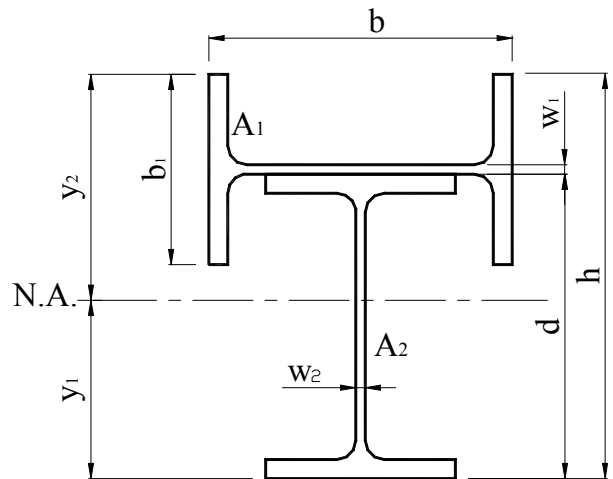

$$A = A_c + A_f$$

$$d_o = d + w$$

$$y_1 = \frac{A_f d/2 + A_c(d_o - x)}{A}$$

$$y_2 = d_o - y_1$$

$$I_{xx} = I_{xf} + I_{yc} + A_f(y_1 - d/2)^2 + A_c(y_2 - x)^2$$

$$S_{x1} = I_{xx}/y_1$$

$$S_{x2} = I_{xx}/y_2$$

$$r_{xx} = \sqrt{I_{xx}/A}$$

$$I_{yy} = I_{yf} + I_{xc}$$

$$S_{yy} = 2I_{yy}/b$$

$$r_{yy} = \sqrt{I_{yy}/A}$$

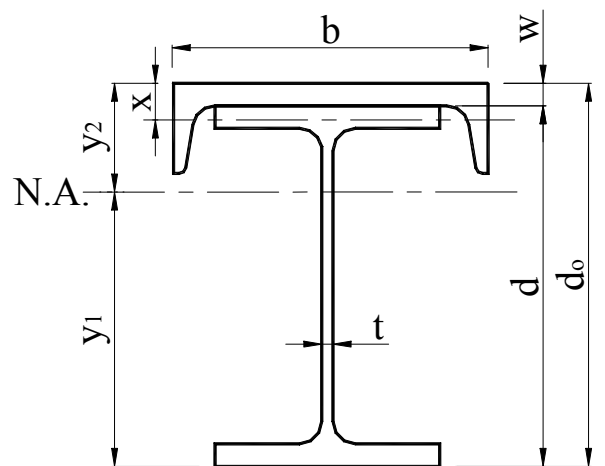

Note: Elements of the shape, which are shown in dotted outline, are continuous and if disconnected the variable defining their size should be set equal to zero.